

# ELECTRICAL

---

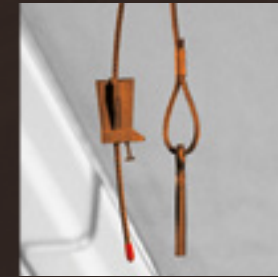

## PRODUCT SOLUTIONS CATALOGUE

**ISSUE 1**



STRENGTH | SUSPENSION | STYLE

A FUSION OF **ENGINEERING** AND **DESIGN**



Copyright of Zip-Clip Ltd 2019

All descriptions and illustrations in this manual are intended for guidance purposes only. Zip-Clip Ltd reserves the right to change the information, products and specifications in this manual for a variety of reasons, without prior notice. The information in this manual is provided "as is" at the date specified on the back cover. Updates will not be issued automatically.

# CONTENTS

---

About Zip-Clip.....	04	Shot-Lock.....	36
Technical information.....	05	Chan-Lock.....	38
How it works.....	06	Strut-Lock.....	40
Zip-Clip electrical solutions .....	07	Plus-on-Wire.....	42
Flexibility of Zip-Clip .....	08	Try-Lock.....	44
Cable tray solutions .....	09	Y-It.....	46
Cable basket solutions.....	10	Luma-Lock.....	48
Trunking and busbar solutions.....	11	Architectural Y-Hanger .....	50
Trapeze bracket solutions .....	12	M6 Male architectural support .....	52
Prefabricated module solutions.....	13	M10 Male architectural support.....	54
Secondary light support solutions.....	13	Architectural support with	
Rize .....	14	M6 female thread.....	56
Zip-Lock.....	16	M6 Ceiling fixing with slot.....	58
Loop-It .....	18	Barrel ceiling fixing .....	60
Con-Lock.....	20	Black-Lock.....	62
Anchor-It.....	22	Zip-Grip .....	64
Thread-It.....	24	Span-Lock.....	66
Dec-Lock .....	26	Zip-Rod.....	68
Knock-It.....	28	Accessories .....	70
Toggle-It.....	30	Prefabrications .....	71
Snap-It .....	32	Specifications.....	72
Uni-Lock .....	34	Environmental policy .....	75



## ABOUT ZIP-CLIP

# WHO IS ZIP-CLIP?

We are manufacturers and designers of high-spec wire suspension systems for all your Electrical, HVAC, Mechanical and Signage requirements.

# WHAT IS IT?

A zip-clip is a device that allows you to join a wire rope to a desired fixing or anchor point. The zip-clip is manufactured from a high quality zinc alloy. The oil impregnated sintered metal wedge is designed to offer the best locking solution. The stainless steel spring ensures the wedge engages first time. The galvanised high tensile wire rope supplied offers you a better SWL than those found on the market. All our engineered suspension products are designed with quality and safety in mind.

# TESTED?

All our products are independently tested by TUV, MELBTEST, SATRA, Lloyds British, UKAS and Apave and all Rize locking devices are UL certificated.

For copies of our test certificates please contact our offices.



## TECHNICAL INFORMATION

### What are the advantages of using a Zip-Clip wire system?

Using a wire rope suspension system provides many advantages:

- Key free release system – No tools required for height adjustment
- Easier to transport
- 100 metre coil is equivalent to 30 x 3 metre lengths of threaded rod
- Easier to handle
- Cold cut, no hot work permit required
- Vibration reduction
- Reduced labour cost
- Reduced risk of injury
- Aesthetics – Low visual impact
- Reduces individual components (i.e. nuts, washers, square plates, rod...)
- Reduces impact on the environment – Less embodied carbon

### Where can I use a wire system?

- Lighting systems including luminaires or tracks
- Cable management including cable basket, cable tray and cable ladder
- Trunking systems including busbar
- High bays
- CCTV cameras and audio equipment
- Secondary support
- Audio systems
- Bracing

For specialist applications, please contact our technical department on 0044 (0) 1686 623366.

### Manufacturers Recommendations?

Zip-Clip's unique system is designed to support **static loads only**. Dynamic and shock loadings can greatly increase the overall weight of the product being suspended and therefore can compromise the Safe Working Load of the suspension.

- To ensure integrity and safety of the systems only Zip-Clip cable should be used
- Do not exceed the Safe Working Load of the product
- Do not use coated cable
- Do not paint or apply any other coating
- Do not apply lubricant
- Do not use for lifting
- Remove any frayed cable end prior to inserting into the clip
- Do not shock load
- Do not overload
- Do not use in a corrosive environment \*
- Do not use in a chlorinated environment \*
- Do not use for dynamic loads/installations

All stated Safe Working Loads and certifications are based on the product being used in conjunction with our high tensile zip-clip wire.

Zip-Clip are not able to guarantee the Safe Working Load of a product used with a non Zip-Clip wire and cannot support projects where non Zip-Clip wire has been used.

\*For specialist applications such as corrosive environments, please contact our technical department on 0044 1686 623366.



Pay attention to the nature of the situation.

Certain installations will result in dynamic forces eg: cable pulling. If this is the case, look to install robust wire supports at certain intervals. See eyebolt assemblies page 12 and 13.

## HOW IT WORKS

- Pass the wire through the zip-clip
- Loop the wire through or around the anchor point
- Pass the wire back through the zip-clip allowing 15cm of wire protruding
- Apply tension
- Always confirm engagement of the zip-clip on the wire by pushing the pin in the opposite direction of the arrows indicated on the zip-clip
- To adjust, take the load off the wire support and pull the tail slightly to disengage the wedge, then release using the adjustment pin – no tools required

### The KL200 can be used to make a figure of eight suspension, using one clip:

- Pass the wire into the “through hole” in the KL200 and then around your fixing or anchor point. Pass the wire end through the locking channel in the KL200 and pull through 15cm of free wire
- Pass the other end of the wire through your bracket or around your anchor point and back through the locking channel allowing 15cm of free wire through the clip
- Always confirm engagement of the zip-clip on the wire by pushing the pin in the opposite direction of the arrows indicated on the zip-clip
- Prior to load being applied, the wire can be adjusted in either direction
- With the load off the wire, push the release pin in the direction of the arrow on the zip-clip. This will release the locking wedge and allow the wire rope to be moved freely in either direction. After a load has been applied, it may be necessary to pull the cable slightly to disengage the teeth on the wedge. Be sure the load is fully supported before attempting adjustment

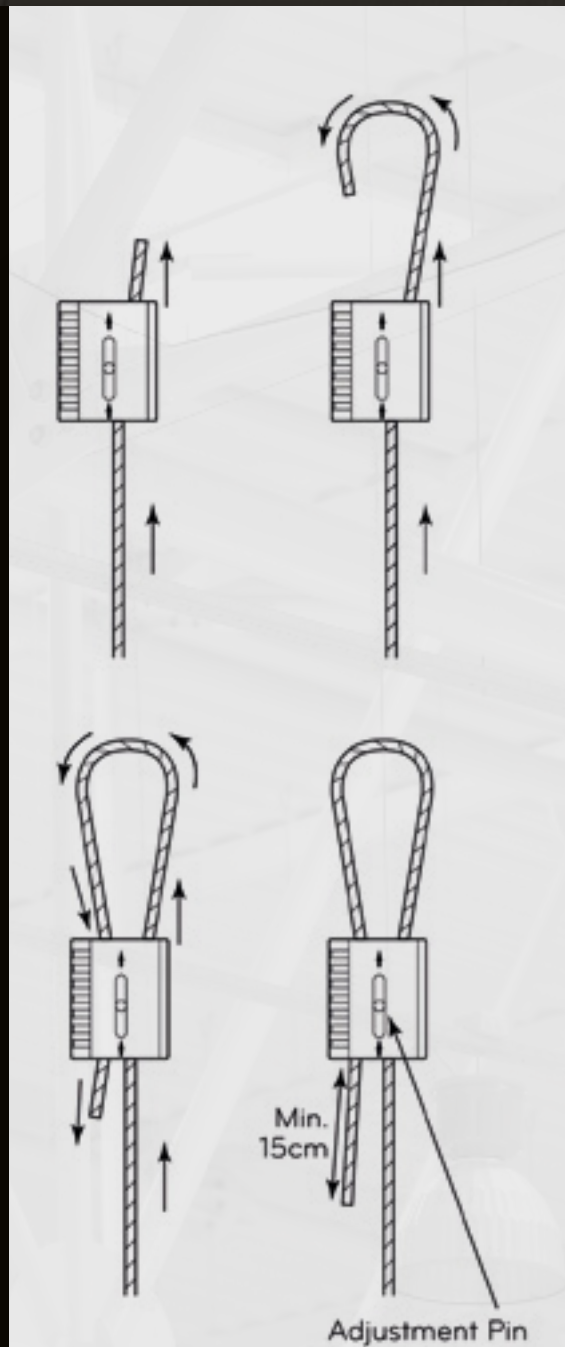
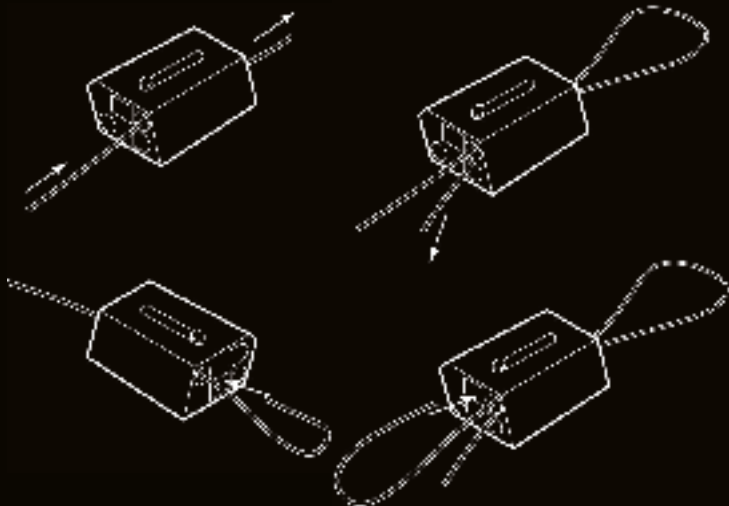

## ZIP-CLIP ELECTRICAL SOLUTIONS

**Zip-Clip wire supports are used as an alternative means of suspension to traditional threaded rod systems.**

**They offer the following main benefits:**

- Quick installation times
- Easy to use, requiring non skilled labour
- Guaranteed weight loadings from 15 – 500kg per wire support which are independently tested and give a 5:1 safety factor
- Easier to store and transport
- Low visual impact
- Array of different fixings to anchor to a variety of base materials
- Array of attachments to fix to a variety of applications

For further information please contact Zip-Clip Technical department on **+44 1686 623366**

## ZIP-CLIP ELECTRICAL SOLUTIONS

### FLEXIBILITY OF ZIP-CLIP

Zip-Clip locking devices can be utilised in different ways to carry out different functions. This is due to the patented wire locking mechanism within each channel.

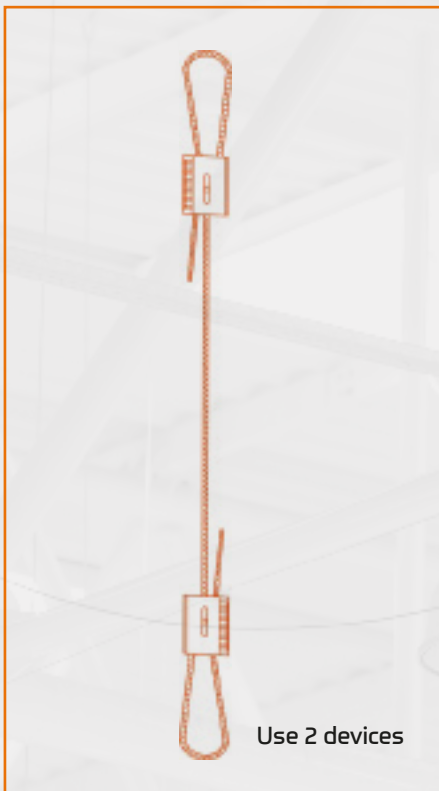

#### Zip-clip top and bottom

**Ideal for:** Long suspensions



#### All round loop

**Ideal for:** Tight void spaces

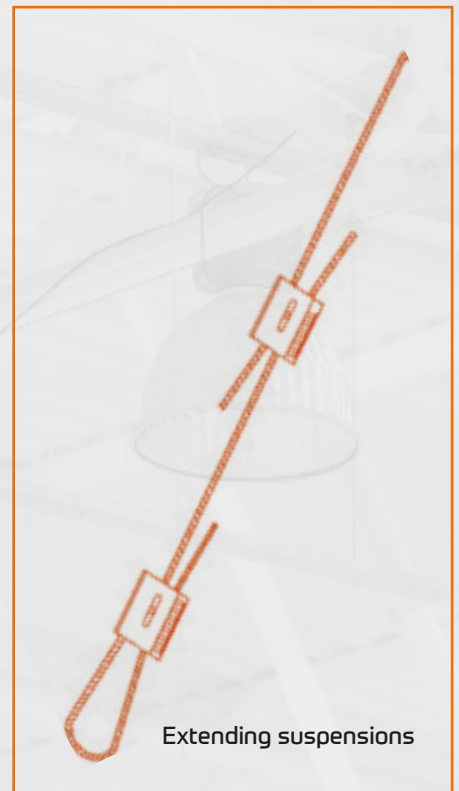

#### In-line joint

**Ideal for:** Extending a cable

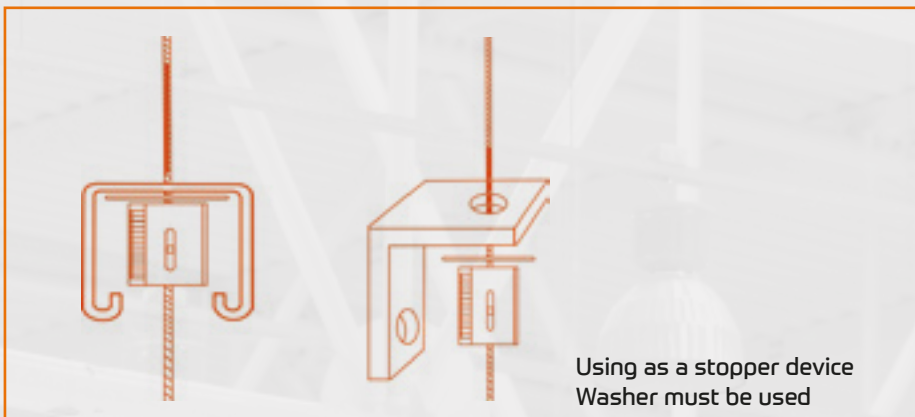

#### Stopper

**Ideal for:** building trapeze brackets  
or using as a stop end



# CABLE TRAY SOLUTIONS

## LUMA-LOCK



### Use for:

- Long suspensions up to 10m
- Cable tray runs
- Off-shoots from the main containment
- Single tier systems
- See pages 48-49

## Y-IT – TOGGLE END

### Use for:

- Short suspensions in tight void spaces or low ceilings
- Cable tray runs
- Off-shoots from the main containment
- Single tier systems
- See pages 46-47

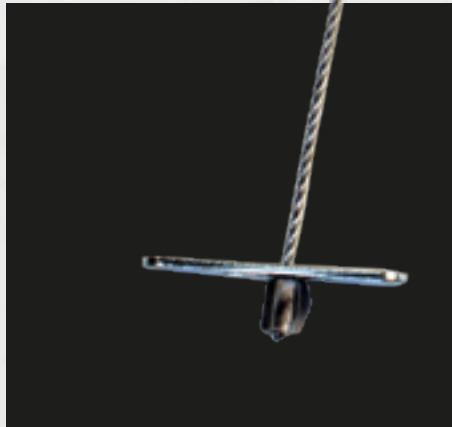

## TOGGLE-IT



### Use for:

- Installing trays into tight void spaces
- Wider cable trays
- Single cable tray runs
- Off-shoots from the main containment
- Reducing the use of profile channel
- See pages 30-31

## CABLE BASKET SOLUTIONS

### TRY-LOCK

#### Use for:

- Long suspensions up to 10m
- Cable basket runs
- Off-shoots from the main containment
- See pages 44-45



### Y-IT – CARABINER END

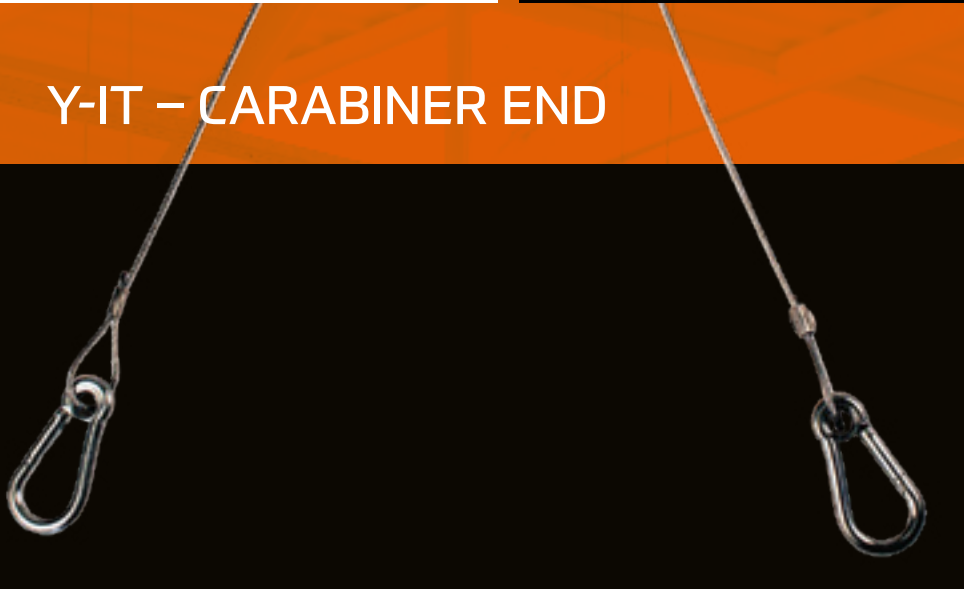

#### Use for:

- Short suspensions in tight void spaces or low ceilings
- Cable basket runs
- Off-shoots from the main containment
- See pages 46-47

### SNAP-IT

#### Use for:

- Installing basket into tight void spaces
- Wider cable basket
- Single cable basket runs
- Off-shoots from the main containment
- Reducing the use of profile channel
- See pages 32-33



# TRUNKING AND BUSBAR SOLUTIONS

## BEST PRACTICE

Utilise components such as stirrups or brackets which accompany trunking in order to connect a wire suspension to the services.

The important element is the method of securely fixing to the trunking or the bus bar.

The best way to achieve this is with Zip-Clip adaptor eye bolts:



Round head version (offering longer thread lengths)

Square head version (offering aesthetics)

### Selecting the Eyebolt:

CODE	HEAD TYPE	LENGTH	LOAD
UNI1	Square	20mm	50kg
UNI2	Square	45mm	50kg
UNI3	Square	25mm	90kg
UNI6M60	Round	60mm	50kg
UNI8M60	Round	60mm	50kg
UNI10M60	Round	60mm	300kg

\* 5:1 Safety Factor

### The Installation

- Utilise an eye bolt adapter to join the wire support to the trunking stirrup (a), or directly loop any available through-holes that may be in the bracket or stirrup (b)
- Install Zip-Clip adaptor eye bolt into stirrup, either:
  - Screw into available female thread
  - Utilise integral nut washer to clamp onto through hole
  - Utilise larger washer to span through hole if required
- Anchor the Zip-Clip wire suspension of choice to the ceiling and join wire rope to eye bolt adapter using zip-clip locking device

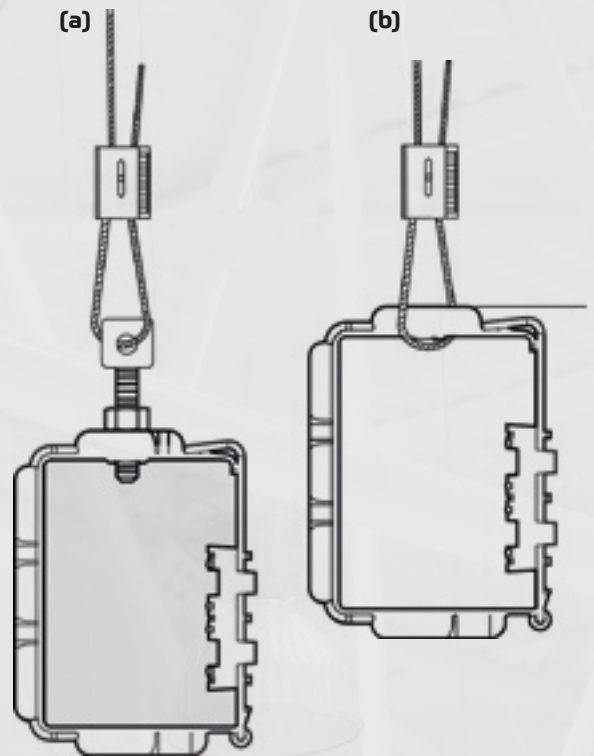

Zip-Clip adaptor eye bolt installed into through-hole offering point of attachment for wire suspension.  
**Note: nuts and washers have been utilised to clamp available through-hole.**



Image showing example of stirrup which accompanies trunking.



Image displaying adapter and wire suspension in-situ, offering a mechanical fix to the services which are secure and level.

## TRAPEZE BRACKET SOLUTIONS

### CHAN-LOCK: For Light Duty Applications

#### Use for:

- Assembling **lightweight** trapeze brackets
- Cable tray and basket runs
- Off-shoots from the main containment
- Single tier systems
- See pages 38-39

#### Important information:

- **For static loads only**
- **Do not overload bracket or go beyond safe working load**
- **Ensure services are loaded evenly, not point loaded**
- **Not for use with heavy installation** eg armoured cable installs
- Chan-lock brackets govern the overall swl of a wire suspension ie. 20Kg per suspension only

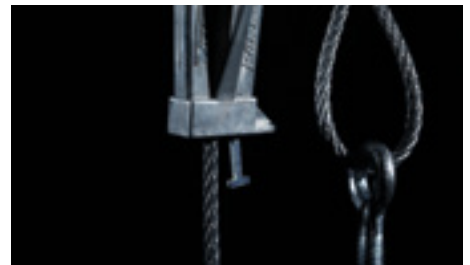

### STRUT-LOCK: For Medium Duty Applications

#### Use for:

- Single and multi-tier systems
- Assembling medium duty trapeze brackets
- Cable tray and basket runs
- Off-shoots from the main containment
- For 41x41 & 41x21 channel
- Attaching to existing bracketry
- See pages 40-41

### EYEBOLT ASSEMBLIES: For Medium to Heavy Duty Applications

#### Use for:

- Assembling heavier duty trapeze brackets
- Cable tray and basket runs
- Off-shoots from the main containment
- Single tier systems
- Ladder wrack containment
- Supporting armoured cable containment
- See pages 24-25

### PLUS-ON-WIRE: For Heavy Duty Applications

#### Use for:

- Assembling heavyweight trapeze brackets
- Supporting modules
- Cable tray and basket runs
- Off-shoots from the main containment
- Single or multi-tier systems
- See pages 42-43

## PREFABRICATED MODULE SOLUTIONS



### STRUT-LOCK:

#### Use for:

- Single and multi-tier systems
- Supporting modules
- Off-shoots from the main containment
- For 41x41 & 41x21 channel
- Attaching to existing bracketry
- See pages 40-41



### PLUS-ON-WIRE:

#### Use for:

- Assembling heavyweight trapeze brackets
- Cable tray and basket runs
- Off-shoots from the main containment
- Single or multi-tier systems
- Supporting modules
- See pages 42-43



### EYEBOLT ASSEMBLIES:

#### Use for:

- Assembling heavier duty trapeze brackets
- Cable tray and basket runs
- Off-shoots from the main containment
- Single tier systems
- Ladder wrack containment
- Supporting armoured cable containment
- Reinforcement:
  - Start and end of trapeze runs
  - Corner junctions or junction trapeze brackets
- See pages 24-25

## SECONDARY LIGHT SUPPORT SOLUTIONS

### RIZE:

The RIZE system can be used to install secondary light supports should this be a project requirement.

#### To link the suspension to the ceiling:

- 1) Join wire rope to suitable ceiling fixing such as an eye bolt
- 2) Or loop the wire rope around an available supporting structure, and lock off with a zip-clip device

#### To link the suspension to a light fixture:

- 1) Identify available connection points in light fitting
- 2) Either install a zip-clip eye bolt adapter to leave a suitable connection point for a wire suspension
- 3) Or thread the wire rope through an available through-hole, and lock off using a zip-clip device

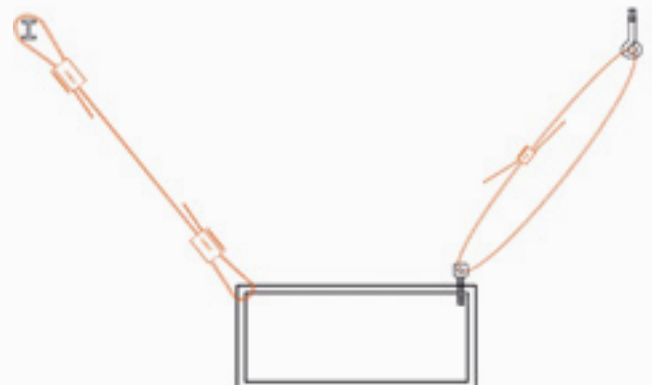

## RIZE



### SUITABLE FOR:

- Wrap around applications such as purlins or I-beams
- Use with a wide range of fixing brackets including: eyebolt adapters, concrete eyebolts, rib deck fixings, purlin clips
- Trapeze Brackets
- Long suspensions
- Roof spaces with varied drop lengths
- Tight void spaces

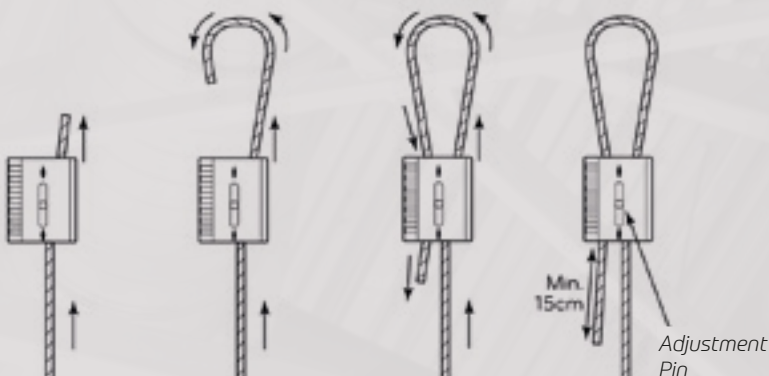

### The Specifics:

The range consists of a choice of wire reels and zip-clips with a choice of Safe Working Loads:

- G 15kg SWL
- S 50kg SWL
- Y 120kg SWL
- P 300kg SWL
- N 500kg SWL

### The Applications

- Trunking and busbar solutions
- Trapeze bracket solutions
- Prefabricated module solutions
- Secondary light support solutions

### The Features and Benefits

- Key free release system
- No pre-site visits required
- Ideal for long drop lengths
- Any spare material can be used on following projects
- Only wire cutter required
- Can be used as a wrap around application and with a wide range of brackets.
- Wire supplied in dispensing box – avoiding risk of wire bird nesting
- Safety factor: 5:1



## The Installation

- Cut wire to desired length for the drop required
- Pass one end of the wire through the zip-clip in the direction of the arrow and draw through enough wire to go around your fixing point
- Pass the wire end back through the zip-clip leaving at least 15cm of free wire protruding
- At the other end again pass the wire through the zip-clip in the direction of the arrow
- Pass the free end of wire around your suspension or through your fixing and back through the zip-clip leaving 15cm of wire protruding
- Always confirm engagement of the zip-clip on the wire by pushing the pin in the opposite direction to the arrows indicated

**Zip-clips are also available in a lockable version offering a tamper proof installation.**

## The Installation:

- Unscrew the M4 locking nut and bolt until the adjustment pin can be pushed back fully
- Pass one end of the wire through the zip-clip in the direction of the arrow and draw enough wire to go around your fixing point
- Pass the wire back through the zip-clip leaving at least 15cm of wire protruding
- Tighten the M4 locking nut and bolt until the adjustment can no longer be moved

CODE	DESCRIPTION	SWL	QTY
KL50	Zip-Clip Rize KL50 15kg SWL	15kg	10
R200G	200 Mtr G wire reel in dispenser box	15kg	1
R100G/SS	100 Mtr stainless steel AISI 316 G wire reel	8kg	1
R200G/SS	200 Mtr stainless steel AISI 316 G wire reel	8kg	1
KL100	Rize KL100 50kg SWL	50kg	10
R100S	100 Mtr S wire reel in dispenser box	50kg	1
R200S	200 Mtr S wire reel in dispenser box	50kg	1
R500S	500 Mtr S Wire Reel	50kg	1
R100S/SS	100 Mtr Stainless Steel AISI 316 S Wire Reel	45kg	1
KL150	Rize KL150 120kg SWL	120kg	10
R100Y	100 Mtr Y Wire Reel	120kg	1
R100Y/SS	100 Mtr Stainless Steel AISI 316 Y Wire Reel	100kg	1
KL200	Rize KL200 300kg SWL	300kg	10
R100P	100 Mtr P Wire Reel	300kg	1
R100P/SS	100 Mtr Stainless Steel AISI 316 P Wire Reel	200kg	1
KL600	Rize KL600 500kg SWL	500kg	10
R100N	100 mtr N wire reel	500kg	1
KL100LOK	Rize KL100 50kg SWL Lockable	50kg	10
KL150LOK	Rize KL150 120kg SWL Lockable	120kg	10
KL200LOK	Rize KL200 300kg SWL Lockable	300kg	10
KL600LOK	Rize KL600 500kg SWL Lockable	500kg	10



USE FOR  
TAILOR MADE  
DROP LENGTHS

## ZIP-LOCK



### SUITABLE FOR:

Wrap around installations including:

- Beams
- Purlins
- Roof Trusses
- Steel framed buildings
- All other existing features



### The Specifics:

The range consists of a pre-determined length of wire from 1 metre to 10 metres with a choice of Safe Working Load:

- G 15kg
- S 50kg
- Y 90kg

The system consists of wire and zip-clip device with a friction free eye termination.

### The Applications

- Trunking and busbar solutions
- Trapeze bracket solutions
- Prefabricated module solutions
- Secondary light support solutions

### The Features and Benefits

- Key free release system
- Precision Swaged Eye
- Frictionless system – No wire on wire
- Simple to use
- Zinc plated with clear trivalent passivate
- Suspension can be inverted
- High tensile galvanised wire 1960N/mm<sup>2</sup> grade 7 x 7 construction
- BSEN 12385 Standard
- Safety factor: 5:1



# WRAP AROUND TERMINATION

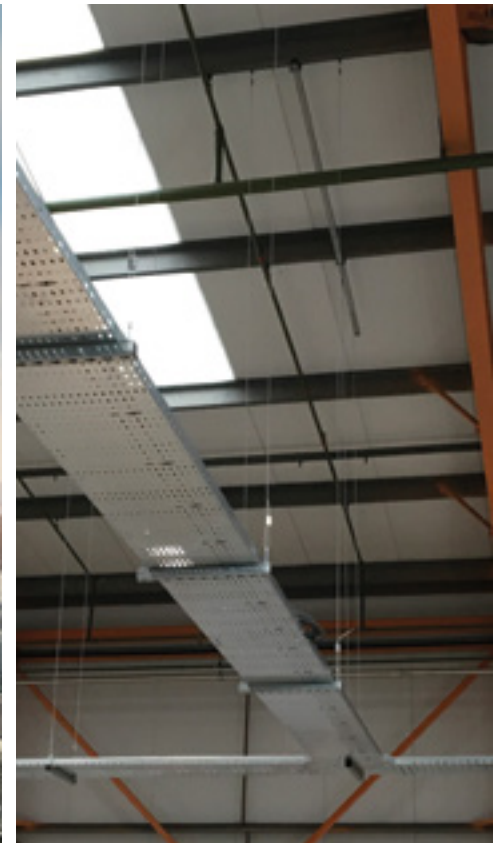

## The Installation

- Pass the wire around your purlin or beam
- Pass the free end of the wire through the eye to create a friction free fixing
- Pass the wire through the zip-clip in the direction of the arrow
- Pass through or around your required suspension and back through the zip-clip leaving 15cm of wire protruding
- Always confirm engagement of the zip-clip on the wire by pushing the pin in the opposite direction to the arrows indicated

CODE	DESCRIPTION	SWL	QTY
ZLG1	1 Mtr eye suspension system	15kg	10
ZLG2	2 Mtr eye suspension system	15kg	10
ZLG3	3 Mtr eye suspension system	15kg	10
ZLG4	4 Mtr eye suspension system	15kg	10
ZLG5	5 Mtr eye suspension system	15kg	10
ZLG10	10 Mtr eye suspension system	15kg	10
ZLS1	1 Mtr eye suspension system	50kg	10
ZLS2	2 Mtr eye suspension system	50kg	10
ZLS3	3 Mtr eye suspension system	50kg	10
ZLS4	4 Mtr eye suspension system	50kg	10
ZLS5	5 Mtr eye suspension system	50kg	10
ZLS10	10 Mtr eye suspension system	50kg	10
ZLY1	1 Mtr eye suspension system	90kg	10
ZLY2	2 Mtr eye suspension system	90kg	10
ZLY3	3 Mtr eye suspension system	90kg	10
ZLY4	4 Mtr eye suspension system	90kg	10
ZLY5	5 Mtr eye suspension system	90kg	5
ZLY10	10 Mtr eye suspension system	90kg	5

## LOOP-IT



### SUITABLE FOR:

Wrap around installations including:

- Beams
- Purlins
- Roof Trusses
- Steel framed buildings
- All other existing features



### The Specifics:

The range consists of a pre-determined length of wire from 1 metre to 10 metres with a choice of Safe Working Load:

- G 15kg SWL
- S 50kg SWL
- Y 90kg SWL
- P 300kg SWL
- N 500kg SWL

The system consists of wire with a ferruled loop termination and a zip-clip device.

### The Applications

- Trunking and busbar solutions
- Trapeze bracket solutions
- Prefabricated module solutions
- Secondary light support solutions

### The Features and Benefits

- Key free release system
- Simple to use
- Suspension can be inverted
- High tensile galvanised wire 1960N/mm<sup>2</sup> grade 7 x 7 construction
- BSEN 12385 standard
- Safety factor: 5:1

## The Installation

- Pass the wire around the purlin or beam
- Pass the free end of the wire through the loop
- Pass the wire through the zip-clip in the direction of the arrow
- Pass through or around the required suspension and back through the zip-clip leaving 15cm of wire protruding
- Always confirm engagement of the zip-clip on the wire by pushing the pin in the opposite direction to the arrows indicated



CODE	DESCRIPTION	SWL	PACK QTY
PLEK1G	1 Mtr standard loop suspension system	15kg	10
PLEK2G	2 Mtr standard loop suspension system	15kg	10
PLEK3G	3 Mtr standard loop suspension system	15kg	10
PLEK4G	4 Mtr standard loop suspension system	15kg	10
PLEK5G	5 Mtr standard loop suspension system	15kg	10
PLEK10G	10 Mtr standard loop suspension system	15kg	10
PLEK1S	1 Mtr standard loop suspension system	50kg	10
PLEK2S	2 Mtr standard loop suspension system	50kg	10
PLEK3S	3 Mtr standard loop suspension system	50kg	10
PLEK4S	4 Mtr standard loop suspension system	50kg	10
PLEK5S	5 Mtr standard loop suspension system	50kg	10
PLEK10S	10 Mtr standard loop suspension system	50kg	10
PLEK1Y	1 Mtr standard loop suspension system	90kg	10
PLEK2Y	2 Mtr standard loop suspension system	90kg	10
PLEK3Y	3 Mtr standard loop suspension system	90kg	10
PLEK4Y	4 Mtr standard loop suspension system	90kg	10
PLEK5Y	5 Mtr standard loop suspension system	90kg	5
PLEK10Y	10 Mtr standard loop suspension system	90kg	5
PLEK1P	1 Mtr standard loop suspension system	300kg	10
PLEK2P	2 Mtr standard loop suspension system	300kg	10
PLEK3P	3 Mtr standard loop suspension system	300kg	10
PLEK4P	4 Mtr standard loop suspension system	300kg	10
PLEK5P	5 Mtr standard loop suspension system	300kg	5
PLEK10P	10 Mtr standard loop suspension system	300kg	5
PLEK1N	1 Mtr standard loop suspension system	500kg	5
PLEK2N	2 Mtr standard loop suspension system	500kg	5
PLEK3N	3 Mtr standard loop suspension system	500kg	5
PLEK4N	4 Mtr standard loop suspension system	500kg	5
PLEK5N	5 Mtr standard loop suspension system	500kg	5
PLEK10N	10 Mtr standard loop suspension system	500kg	5

## WRAP AROUND TERMINATION

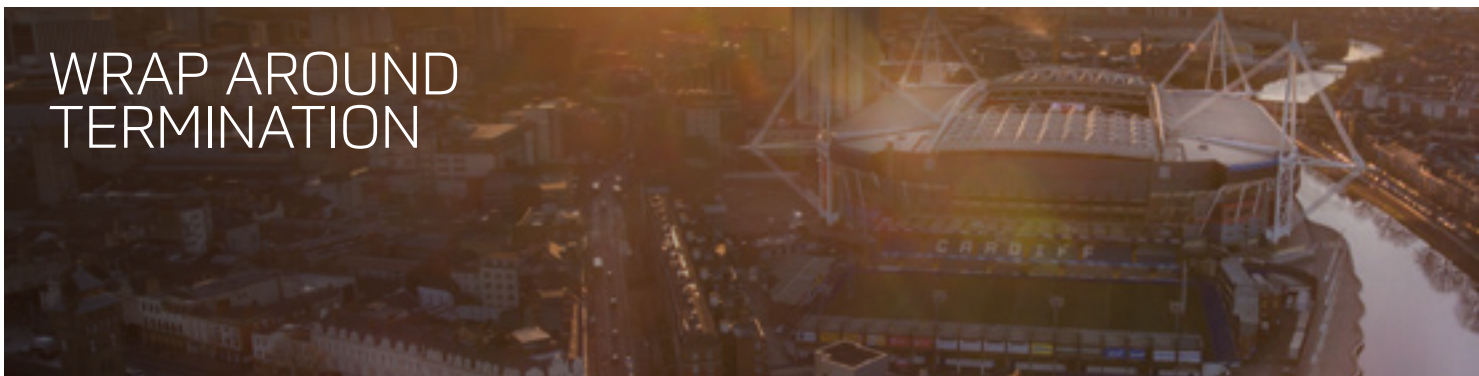

## CON-LOCK



### SUITABLE FOR:

Concrete applications including:

- Cracked concrete
- Reinforced concrete
- Slagged concrete
- Hollow pot

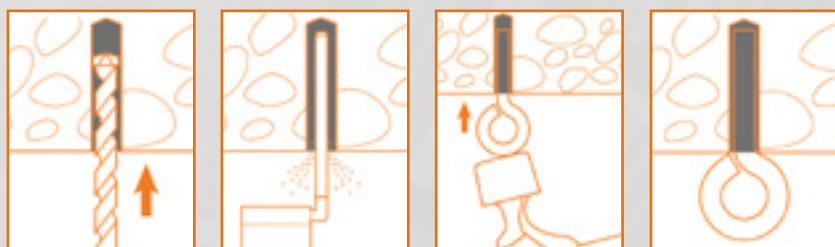

### BS8539 Compliant

### The Specifics:

The range consists of a pre-determined length of wire from 1 metre to 10 metres with a choice of Safe Working Load:

- G 15kg
- S 50kg
- Y 90kg

The system consists of wire and zip-clip device with a CLA1 concrete anchor termination.

### The Applications

- Trunking and busbar solutions
- Trapeze bracket solutions
- Prefabricated module solutions
- Secondary light support solutions

### The Features and Benefits

- Key free release system
- No claw back required
- Nail anchor for hammer set installation
- The installed nail anchor expands automatically under load, pulls the cone into the expansion clip and expands against the wall of the concrete
- Can also be supplied with a double drop
- Shallow embedment
- ETA approved
- BS8539 Compliant
- High tensile galvanised wire 1960 N/mm<sup>2</sup> grade 7 x 7 construction
- BSEN 12385 standard
- Safety factor: 5:1
- Suitable for cracked and non-cracked concrete

**BS8539 Compliant**

**The Installation**

- Drill a 6mm hole to a minimum depth of 30mm
- Blow the hole clean of dust and debris
- Hammer in the fixing
- Anchor is now fixed, no claw back required
- Pass the wire through the zip-clip in the direction of the arrow
- Pass through or around your required suspension and back through the zip-clip leaving 15cm of wire protruding
- Always confirm engagement of the zip-clip on the wire by pushing the pin in the opposite direction to the arrows indicated

CODE	DESCRIPTION	SWL	QTY
CLG1	1 Mtr concrete suspension system	15kg	10
CLG2	2 Mtr concrete suspension system	15kg	10
CLG3	3 Mtr concrete suspension system	15kg	10
CLG4	4 Mtr concrete suspension system	15kg	10
CLG5	5 Mtr concrete suspension system	15kg	10
CLG10	10 Mtr concrete suspension system	15kg	10
CLS1	1 Mtr concrete suspension system	50kg	10
CLS2	2 Mtr concrete suspension system	50kg	10
CLS3	3 Mtr concrete suspension system	50kg <td 10	
CLS4	4 Mtr concrete suspension system	50kg	10
CLS5	5 Mtr concrete suspension system	50kg	10
CLS10	10 Mtr concrete suspension system	50kg	10
CLY1	1 Mtr concrete suspension system	90kg	10
CLY2	2 Mtr concrete suspension system	90kg	10
CLY3	3 Mtr concrete suspension system	90kg	10
CLY4	4 Mtr concrete suspension system	90kg	10
CLY5	5 Mtr concrete suspension system	90kg	5
CLY10	10 Mtr concrete suspension system	90kg	5



## ANCHOR-IT



### SUITABLE FOR:

Lightweight concrete applications including:

- Lightweight electrical applications
- Solid brick
- Compressive resistant stone
- Reinforced concrete
- Slagged concrete C15/C35

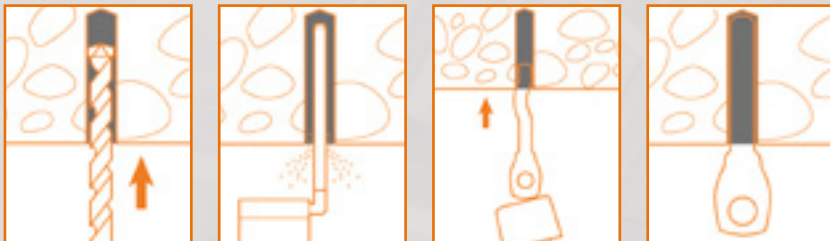

### The Specifics:

The range consists of a pre-determined length of wire from 1 metre to 10 metres with a choice of Safe Working Load:

- G 15kg SWL
- S 35kg SWL

The system consists of wire and zip-clip device with a ferruled CLA2 concrete anchor termination.

### The Applications

- Trunking and busbar solutions
- Trapeze bracket solutions
- Prefabricated module solutions
- Secondary light support solutions

### The Features and Benefits

- Key free release system
- Vibration resistant
- Zinc plated pre-expanded through bolt
- 30mm long
- 5mm wide
- 6mm head width
- 30mm embedment depth
- 5mm drill diameter required
- High tensile galvanised wire 1960N/mm<sup>2</sup> grade 7 x 7 construction
- BSEN 12385 standard
- Safety factor: 5:1

## The Installation

- Drill a 5mm hole to a minimum depth of 30mm
- Blow the hole clean of dust and debris
- Drive the anchor into the hole until the head is firmly seated against the base material. Be sure the anchor is driven to the required embedment depth
- Pass the wire through the zip-clip in the direction of the arrow
- Pass through or around your required suspension and back through the zip-clip leaving 15cm of wire protruding
- Always confirm engagement of the zip-clip on the wire by pushing the pin in the opposite direction to the arrows indicated

CODE	DESCRIPTION	SWL	PACK QTY
PLCAK1G	1 Mtr standard concrete suspension system	15kg	10
PLCAK2G	2 Mtr standard concrete suspension system	15kg	10
PLCAK3G	3 Mtr standard concrete suspension system	15kg	10
PLCAK4G	4 Mtr standard concrete suspension system	15kg	10
PLCAK5G	5 Mtr standard concrete suspension system	15kg	10
PLCAK10G	10 Mtr standard concrete suspension system	15kg	10
PLCAK1S	1 Mtr standard concrete suspension system	35kg	10
PLCAK2S	2 Mtr standard concrete suspension system	35kg	10
PLCAK3S	3 Mtr standard concrete suspension system	35kg	10
PLCAK4S	4 Mtr standard concrete suspension system	35kg	10
PLCAK5S	5 Mtr standard concrete suspension system	35kg	10
PLCAK10S	10 Mtr standard concrete suspension system	35kg	10



CONCRETE FIXING  
TERMINATION

## THREAD-IT



### SUITABLE FOR:

- Link male thread to female threaded fixings to attach wire support to a number of different ceiling types
- Concrete ceilings
- Rib deck ceilings
- Profile channel
- Lindapter rib deck wedges
- Profile channel nuts
- Eyebolt assemblies

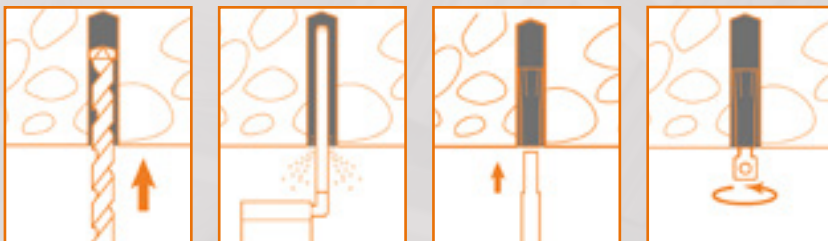
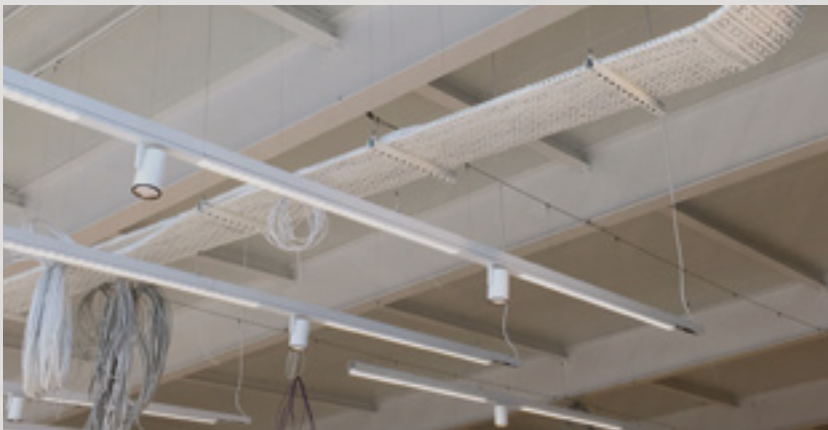

### The Specifics:

The range consists of a predetermined length of wire from 1 metre to 10 metres with a choice of Safe Working Load:

- G 15kg SWL – M6 x 20 threaded end
- S 50kg SWL – M6 x 45 or M8 x 25 threaded end
- Y 90kg SWL – M8 x 25 threaded end

The system consists of wire and zip-clip device with a choice of M6 or M8 threaded termination.

### The Applications

- Trunking and busbar solutions
- Trapeze bracket solutions
- Prefabricated module solutions
- Secondary light support solutions

### The Features and Benefits

- Key free release system
- Comes with M6 or M8 eyebolt as standard
- Other eyebolts available on request
- Suspension can be inverted
- High tensile galvanised wire 1960N/mm<sup>2</sup> grade 7 x 7 construction
- BSEN 12385 standard
- Safety factor: 5:1



## The Installation

- For use in concrete, ensure that the drop in anchor is correctly fixed then thread the M6/M8 stud into place:
  - Install drop in anchor to manufacturer's instructions
  - Ensure correct setting tool is used
- Pass the wire through the zip-clip in the direction of the arrow
- Pass through or around your required suspension and back through the zip-clip leaving 15cm of wire protruding
- The stud can be used in reverse configuration and threaded into the product to be suspended
- Always confirm engagement of the zip-clip on the wire by pushing the pin in the opposite direction to the arrows indicated



CEILING  
OR FIXTURE  
TERMINATIONS



CODE	DESCRIPTION	SWL	PACK QTY
PLTRK1G/M6X20	1 M standard M6x20 threaded suspension system	15kg	10
PLTRK2G/M6X20	2 M standard M6x20 threaded suspension system	15kg	10
PLTRK3G/M6X20	3 M standard M6x20 threaded suspension system	15kg	10
PLTRK4G/M6X20	4 M standard M6x20 threaded suspension system	15kg	10
PLTRK5G/M6X20	5 M standard M6x20 threaded suspension system	15kg	10
PLTRK10G/M6X20	10 M standard M6x20 threaded suspension system	15kg	10
PLTRK1S/M6X45	1 M standard M6x45 threaded suspension system	50kg	10
PLTRK2S/M6X45	2 M standard M6x45 threaded suspension system	50kg	10
PLTRK3S/M6X45	3 M standard M6x45 threaded suspension system	50kg	10
PLTRK4S/M6X45	4 M standard M6x45 threaded suspension system	50kg	10
PLTRK5S/M6X45	5 M standard M6x45 threaded suspension system	50kg	10
PLTRK10S/M6X45	10 M standard M6x45 threaded suspension system	50kg	10
PLTRK1S/M8X25	1 M standard M8x25 threaded suspension system	50kg	10
PLTRK2S/M8X25	2 M standard M8x25 threaded suspension system	50kg	10
PLTRK3S/M8X25	3 M standard M8x25 threaded suspension system	50kg	10
PLTRK4S/M8X25	4 M standard M8x25 threaded suspension system	50kg	10
PLTRK5S/M8X25	5 M standard M8x25 threaded suspension system	50kg	10
PLTRK10S/M8X25	10 M standard M8x25 threaded suspension system	50kg	10
PLTRK1Y/M8X25	1 M standard M8x25 threaded suspension system	90kg	10
PLTRK2Y/M8X25	2 M standard M8x25 threaded suspension system	90kg	10
PLTRK3Y/M8X25	3 M standard M8x25 threaded suspension system	90kg	10
PLTRK4Y/M8X25	4 M standard M8x25 threaded suspension system	90kg	10
PLTRK5Y/M8X25	5 M standard M8x25 threaded suspension system	90kg	5
PLTRK10Y/M8X25	10 M standard M8x25 threaded suspension system	90kg	5

Eyebolt sizes also available – offering longer thread lengths.

CODE	DESCRIPTION	PACK QTY
UNI6M60	M6 x 50mm eyebolt	10
UNI8M60	M8 x 60mm eyebolt	10
UNI10M60	M10 x 75mm eyebolt	10

Eyebolt assemblies available.

CODE	DESCRIPTION	PACK QTY
UNI2/ASSY	M6 x 45 eyebolt assembly	10
UNI3/ASSY	M8 x 25 eyebolt assembly	10
UNI8/ASSY	M8 x 60 eyebolt assembly	10
UNI10/ASSY	M10 x 60 eyebolt assembly	10

## DEC-LOCK



### SUITABLE FOR:

Decking applications including:

- Kingspan
- Structural Metal Decks (SMD) and other steel decking manufacturers
- Concrete over metal rib-deck
- Please refer to opposite table for further details

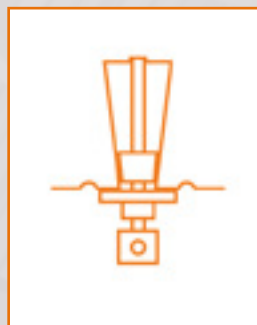
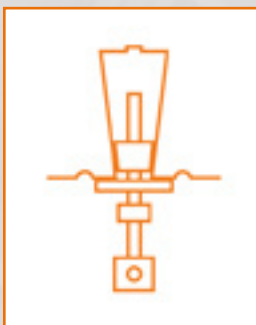
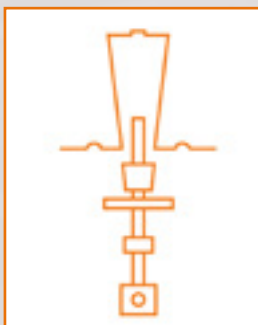

### The Specifics:

The range consists of a pre-determined length of wire from 1 metre to 10 metres with a choice of Safe Working Loads:

- G 15kg
- S 50kg

The system consists of wire and zip-clip device with a decking fixing termination.

### The Applications

- Trunking and busbar solutions
- Trapeze bracket solutions
- Prefabricated module solutions
- Secondary light support solutions

### The Features and Benefits

- Key free release system
- All components are fully assembled
- No onsite assembly required
- Lockable system, no drilling required
- Suitable where access to purlin is not available
- CNC engineered M6 x 45mm eyelet
- Trivalent zinc and clear passivated eyelet, nut and washer
- High tensile galvanised wire 1960 N/mm<sup>2</sup> grade 7 x 7 construction
- BSEN 12385 Standard
- Safety factor: 5:1

## The Installation

- Push the deck wedge into decking profile and turn through 90 degrees
- Screw the eyebolt to the top of the decking profile
- Pass the wire through the zip-clip in the direction of the arrow
- Pass through or around your required suspension and back through the zip-clip leaving 15cm of wire protruding
- Always confirm engagement of the zip-clip on the wire by pushing the pin in the opposite direction to the arrows indicated

CODE	DESCRIPTION	SWL	PACK QTY
DLG1	1 Mtr decking suspension system	15kg	10
DLG2	2 Mtr decking suspension system	15kg	10
DLG3	3 Mtr decking suspension system	15kg	10
DLG4	4 Mtr decking suspension system	15kg	10
DLG5	5 Mtr decking suspension system	15kg	10
DLG10	10 Mtr decking suspension system	15kg	10
DLS1	1 Mtr decking suspension system	50kg	10
DLS2	2 Mtr decking suspension system	50kg	10
DLS3	3 Mtr decking suspension system	50kg	10
DLS4	4 Mtr decking suspension system	50kg	10
DLS5	5 Mtr decking suspension system	50kg	10
DLS10	10 Mtr decking suspension system	50kg	10

### LINDAPTER FIXINGS ALSO AVAILABLE

CODE	DESCRIPTION	SWL	PACK QTY
MAAW/M6	AW Alphawedge M6	100kg	10
MAAW/M8	AW Alphawedge M8	100kg	10
MAMF60/M6	MF60 /decking fixing (met nut & bracket) M6	100kg	10
MAMF80/M8	MF60 /decking fixing (met nut & bracket) M8	100kg	10
MAMW2/M6	MW2 Multiwedge M6	100kg	10
MAMW2/M8	MW2 Multiwedge M8	100kg	10
MATR60/M6	TR60 wedge c/w locking plate – M6	100kg	10
MATR60/M8	TR60 wedge c/w locking plate – M8	100kg	10

SWL applicable to fixing ends only, Safety Factor 3:1

DECKING TYPE	STANDARD WEDGE: Size: 25mm (Top of Wedge) x 18mm (Base of Wedge) x 12mm (Width)	MINI WEDGE: Size: 19mm (Top of Wedge) x 12mm (Base of Wedge) x 9.5mm (Width)	MINI MINI WEDGE: Size: 18.5mm (top of Wedge) x 10mm (Base of Wedge) x 9.5mm (Width)
Richard Lees Holrib	•		
Richard Lees Super Holrib	•		
Quickspan Decking Q51	•		
Corus/Tata CF51	•		
Alpha Decking Alparib	•		
SMD R51	•		
Ward Multideck 50	•		
Corus/Tata NSD	•		
Kingspan Multideck 50-V2	•		
CMF Decking Metfloor 55	•		
Richard Lees Ribdeck 60 profile		•	
Quickspan Decking Q60		•	
Richard Lees Ribdeck 80 Profile			•
PMF Decking CF70			•

## KNOCK-IT



### SUITABLE FOR:

- Knocking onto purlins
- Vertical flange
- 1-5mm flanges
- 5-7mm flanges
- 90 degree purlin clips also available for Kingspan purlins



### The Specifics:

The range consists of a pre-determined length of wire from 1 metre to 10 metres with a choice of Safe Working Load:

- G 15kg SWL
- S 35kg SWL

The system consists of wire and zip-clip device with a purlin fixing termination.

### The Applications

- Trunking and busbar solutions
- Trapeze bracket solutions
- Secondary light support solutions
- Lighting
- Cable tray
- Acoustic boards

### The Features and Benefits

- Key free release system
- Available with both 1-5mm and 5-7mm purlin clips as standard
- Other hangers available on request
- High tensile galvanised wire 1960N/mm<sup>2</sup> grade 7 x 7 construction
- BSEN 12385 standard
- Safety factor: 5:1



# FIXING TO PURLIN STEELS



## The Installation

- Hook purlin clip over the lip of the purlin. Strike with hammer to ensure a secure fixing
- Pass the wire through the zip-clip in the direction of the arrow
- Pass through or around your required suspension and back through the zip-clip leaving 15cm of wire protruding
- Always confirm engagement of the zip-clip on the wire by pushing the pin in the opposite direction to the arrows indicated



T920518

CODE	DESCRIPTION	SWL	PACK QTY
VLG1	1 Mtr standard 1-5mm decking suspension system	15kg	10
VLG2	2 Mtr standard 1-5mm decking suspension system	15kg	10
VLG3	3 Mtr standard 1-5mm decking suspension system	15kg	10
VLG4	4 Mtr standard 1-5mm decking suspension system	15kg	10
VLG5	5 Mtr standard 1-5mm decking suspension system	15kg	10
VLG10	10 Mtr standard 1-5mm decking suspension system	15kg	10
VLS1	1 Mtr standard 1-5mm decking suspension system	35kg	10
VLS2	2 Mtr standard 1-5mm decking suspension system	35kg	10
VLS3	3 Mtr standard 1-5mm decking suspension system	35kg	10
VLS4	4 Mtr standard 1-5mm decking suspension system	35kg	10
VLS5	5 Mtr standard 1-5mm decking suspension system	35kg	10
VLS10	10 Mtr standard 1-5mm decking suspension system	35kg	10
VLG1/2	1 Mtr standard 5-7mm decking suspension system	15kg	10
VLG2/2	2 Mtr standard 5-7mm decking suspension system	15kg	10
VLG3/2	3 Mtr standard 5-7mm decking suspension system	15kg	10
VLG4/2	4 Mtr standard 5-7mm decking suspension system	15kg	10
VLG5/2	5 Mtr standard 5-7mm decking suspension system	15kg	10
VLG10/2	10 Mtr standard 5-7mm decking suspension system	15kg	10
VLS1/2	1 Mtr standard 5-7mm decking suspension system	35kg	10
VLS2/2	2 Mtr standard 5-7mm decking suspension system	35kg	10
VLS3/2	3 Mtr standard 5-7mm decking suspension system	35kg	10
VLS4/2	4 Mtr standard 5-7mm decking suspension system	35kg	10
VLS5/2	5 Mtr standard 5-7mm decking suspension system	35kg	10
VLS10/2	10 Mtr standard 5-7mm decking suspension system	35kg	10

Fixing end also available for 90 degree flange

CODE	DESCRIPTION	SWL	PACK QTY
T920518	90 Degree purlin clip for Kingspan	35kg	10

Please ensure the loadings are within the purlin manufacturer's guidelines.  
If a higher loading is required please refer to our wrap around systems.

## TOGGLE-IT



### SUITABLE FOR:

- Lighting
- Cable tray
- Thin tin roofs
- Fixing into through holes

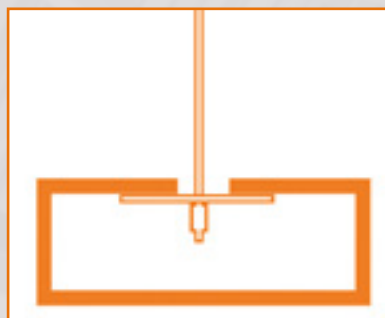
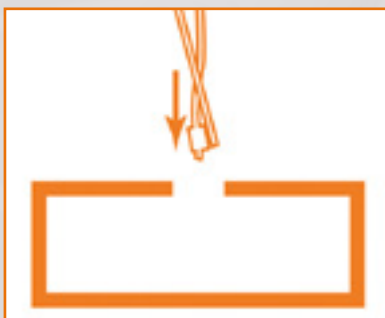
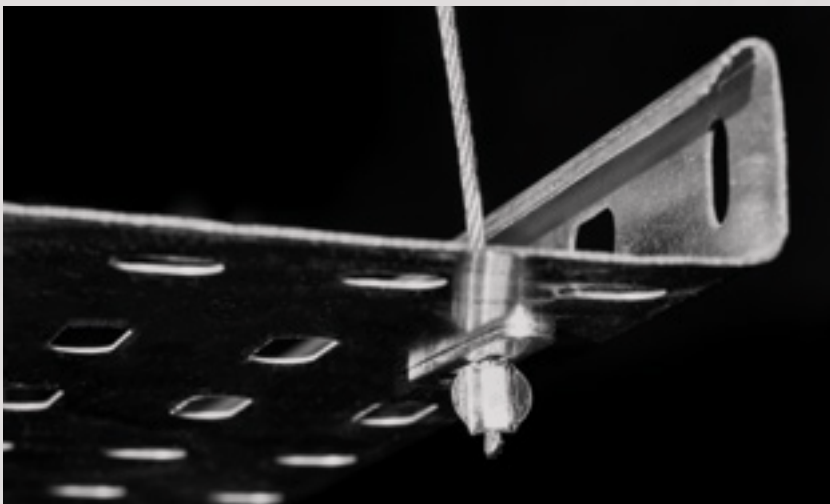

### The Specifics:

The range consists of a predetermined length of wire from 1 metre to 10 metres with a choice of Safe Working Load:

- G 15kg SWL
- S 35kg SWL
- Y 90kg SWL

The system consists of wire and zip-clip device with a toggle termination.

### The Applications

- Cable tray solutions
- Trunking and busbar solutions
- Secondary light support solutions

### The Features and Benefits

- Key free release system
- Three different toggles available to suit light and medium weight applications
- BZP toggles
- Suspension can be inverted
- High tensile galvanised wire 1960N/mm<sup>2</sup> grade 7 x 7 construction
- BSEN 12385 standard
- Safety factor: 5:1

## The Installation

- By inverting the toggle parallel to the wire it will swing through 90 degrees
- Push into the product being suspended
- Ensure hole is no larger than 12mm diameter
- Pass the free end of the wire through the zip-clip in the direction of the arrow
- Pass through or around your required suspension and back through the zip-clip leaving 15cm of wire protruding
- Always confirm engagement of the zip-clip on the wire by pushing the pin in the opposite direction to the arrows indicated

CODE	DESCRIPTION	SWL	PACK QTY
PTE1GK	1 Mtr standard toggle suspension system	15kg	10
PTE2GK	2 Mtr standard toggle suspension system	15kg	10
PTE3GK	3 Mtr standard toggle suspension system	15kg	10
PTE4GK	4 Mtr standard toggle suspension system	15kg	10
PTE5GK	5 Mtr standard toggle suspension system	15kg	10
PTE10GK	10 Mtr standard toggle suspension system	15kg	10
PTE1SK	1 Mtr standard toggle suspension system	35kg	10
PTE2SK	2 Mtr standard toggle suspension system	35kg	10
PTE3SK	3 Mtr standard toggle suspension system	35kg	10
PTE4SK	4 Mtr standard toggle suspension system	35kg	10
PTE5SK	5 Mtr standard toggle suspension system	35kg	10
PTE10SK	10 Mtr standard toggle suspension system	35kg	10
PTE1YK	1 Mtr standard toggle suspension system	90kg	10
PTE2YK	2 Mtr standard toggle suspension system	90kg	10
PTE3YK	3 Mtr standard toggle suspension system	90kg	10
PTE4YK	4 Mtr standard toggle suspension system	90kg	10
PTE5YK	5 Mtr standard toggle suspension system	90kg	5
PTE10YK	10 Mtr standard toggle suspension system	90kg	5

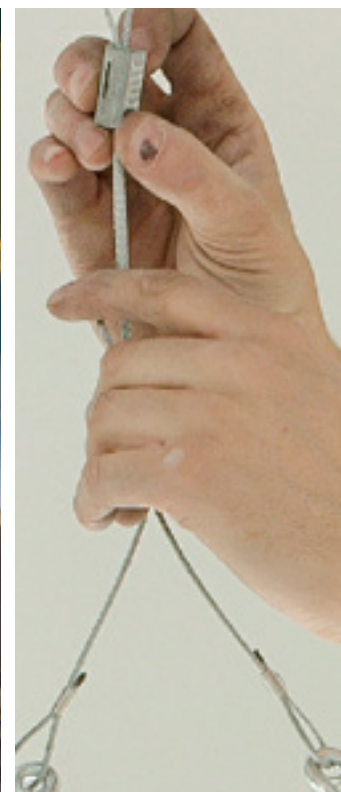

## SNAP-IT



### SUITABLE FOR:

- Lighting
- Attaching to existing structures
- Coupling to eyebolts
- Connecting to through-holes
- Linking with fixings

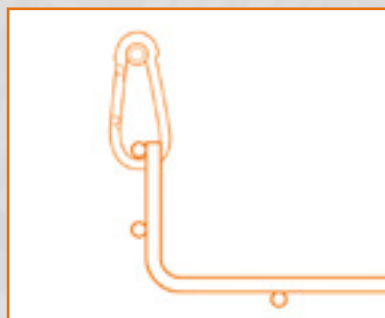
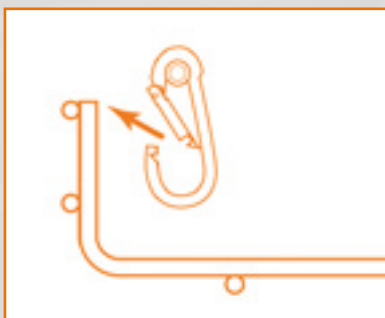

### The Specifics:

The range consists of a pre-determined length of wire from 1 metre to 10 metres with a choice of Safe Working Load:

- G 15kg SWL
- S 45kg SWL
- Y 90kg SWL

The system consists of wire and zip-clip device with an eyelet carabiner termination.

### The Applications

- Cable basket solutions
- Trunking and busbar solutions
- Secondary light support solutions
- Snapping onto purlin fixings
- Lighting
- Coupling to eyebolts
- Attaching to existing structures

### The Features and Benefits

- Key free release system
- Simple to use
- 5 x 50 on G and S range and 6 x 60 on Y range BZP carabiner hook
- Eyelet prevents accidental un-hooking of carabiner from wire
- Maintenance friendly
- Suspension can be inverted
- High tensile galvanised wire 1960N/mm<sup>2</sup> grade 7 x 7 construction
- BSEN 12385 standard
- Safety factor: 5:1



## The Installation

- Snap the carabiner onto the purlin hanger or product to be supported
- Pass the wire through the zip-clip in the direction of the arrow
- Pass through or around your required suspension and back through the zip-clip leaving 15cm of wire protruding
- Always confirm engagement of the zip-clip on the wire by pushing the pin in the opposite direction to the arrows indicated

CODE	DESCRIPTION	SWL	PACK QTY
PSEK1G	1 Mtr standard eyelet carabiner suspension system	15kg	10
PSEK2G	2 Mtr standard eyelet carabiner suspension system	15kg	10
PSEK3G	3 Mtr standard eyelet carabiner suspension system	15kg	10
PSEK4G	4 Mtr standard eyelet carabiner suspension system	15kg	10
PSEK5G	5 Mtr standard eyelet carabiner suspension system	15kg	10
PSEK10G	10 Mtr standard eyelet carabiner suspension system	15kg	10
PSEK1S	1 Mtr standard eyelet carabiner suspension system	45kg	10
PSEK2S	2 Mtr standard eyelet carabiner suspension system	45kg	10
PSEK3S	3 Mtr standard eyelet carabiner suspension system	45kg	10
PSEK4S	4 Mtr standard eyelet carabiner suspension system	45kg	10
PSEK5S	5 Mtr standard eyelet carabiner suspension system	45kg	10
PSEK10S	10 Mtr standard eyelet carabiner suspension system	45kg	10
PSEK1Y	1 Mtr standard eyelet carabiner suspension system	90kg	10
PSEK2Y	2 Mtr standard eyelet carabiner suspension system	90kg	10
PSEK3Y	3 Mtr standard eyelet carabiner suspension system	90kg	10
PSEK4Y	4 Mtr standard eyelet carabiner suspension system	90kg	10
PSEK5Y	5 Mtr standard eyelet carabiner suspension system	90kg	5
PSEK10Y	10 Mtr standard eyelet carabiner suspension system	90kg	5

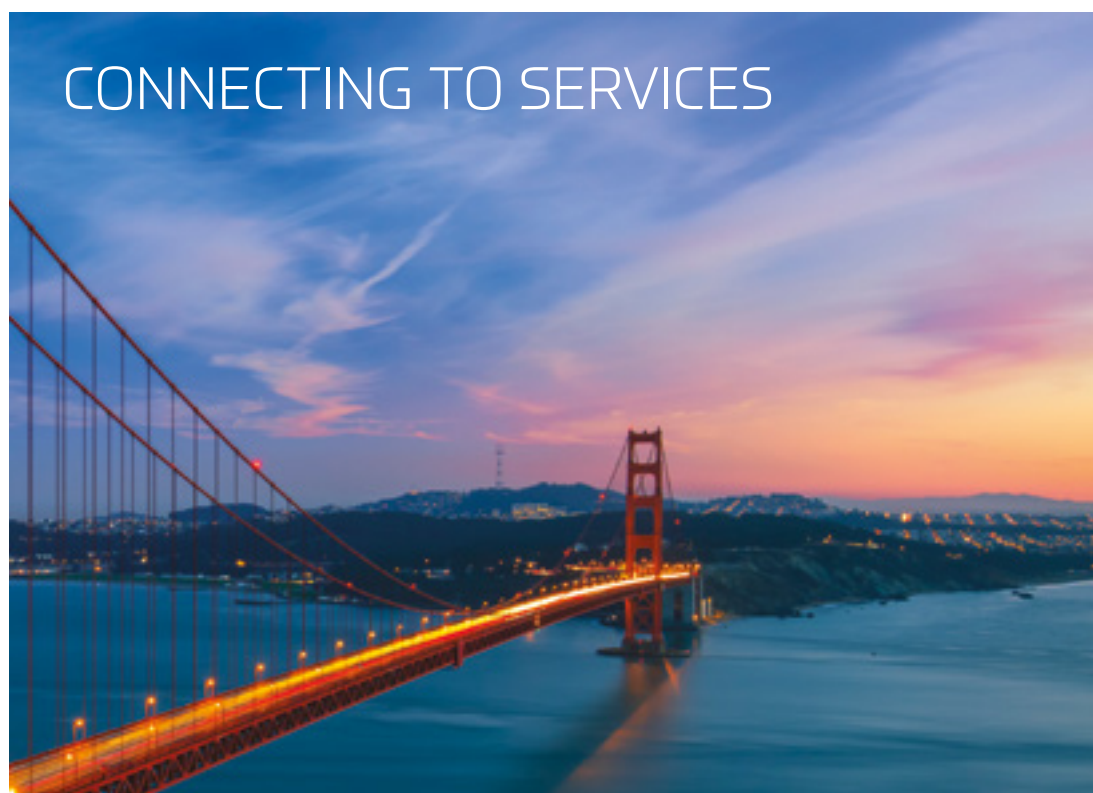

CONNECTING TO SERVICES

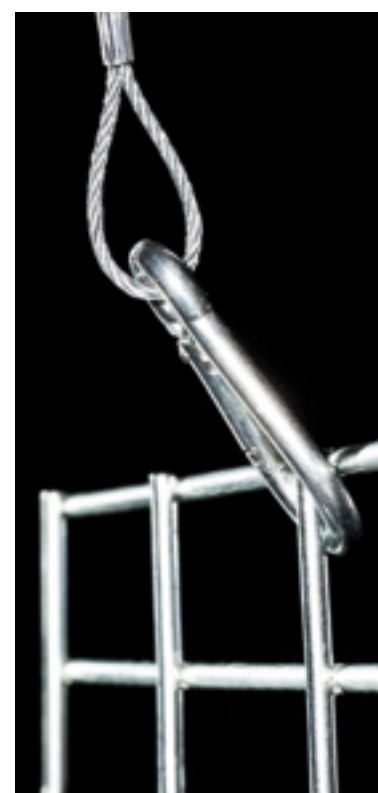

## UNI-LOCK



## SUITABLE FOR:

- Concrete Slab
- Metal decking and other steel structures
- Wooden structures
- Plasterboard ceilings
- Trunking and busbar solutions
- Trapeze bracket solutions
- Prefabricated module solutions
- Secondary light support solutions
- Link with a suitable fixing to attach the wire suspension to the base material

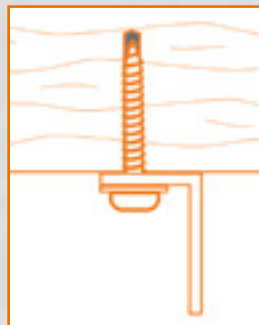
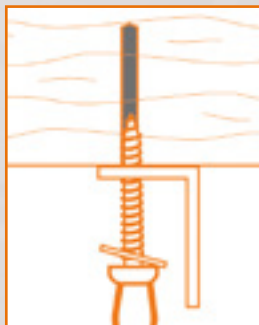
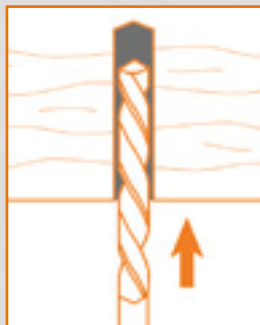

## The Specifics:

The range consists of a pre-determined length of wire from 1 metre to 10 metres with a choice of Safe Working Loads:

- G 15kg SWL (Gas Nail/Screw)
- S 50kg SWL

The system consists of wire and zip-clip device with a right angle bracket termination.

## The Applications

- Trunking and busbar solutions
- Trapeze bracket solutions
- Prefabricated module solutions
- Secondary light support solutions

## The Features and Benefits

- Key free release system
- Suitable for both plug and screw and shot fire applications
- Tear drop shape allows for wire to rotate through 180 degrees in the bracket for angled applications
- Wire rotation reduces pressure on the nail when service is not directly below anchor point
- Delta Tone 9000 coated
- Fix with:
  - Wood screw
  - Plug and screw
  - Concrete screw
  - Tek screw
  - Gas/Pat nail
- Suspension can be inverted
- High tensile galvanised wire 1960 N/mm<sup>2</sup> grade 7 x 7 construction
- BSEN 12385 Standard
- Safety factor: 5:1

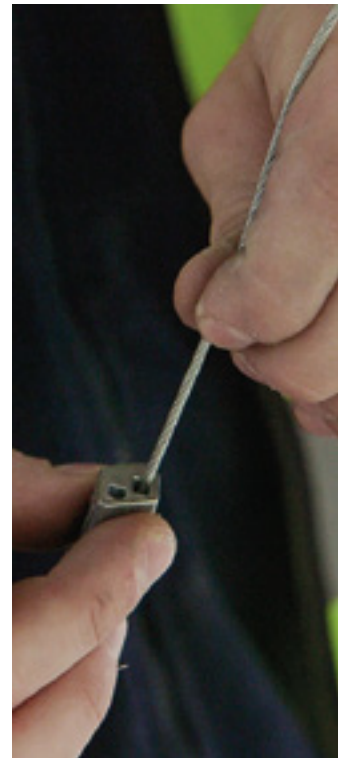

## The Installation

- For timber applications, pre-drill timber and use a screw to fix through the bracket
- For steel and concrete applications use self tapping fixing or a gas nailer with a suitable nail
- Pass the wire through the zip-clip in the direction of the arrow
- Pass through or around your required suspension and back through the zip-clip leaving 15cm of wire protruding
- Always confirm engagement of the zip-clip on the wire by pushing the pin in the opposite direction to the arrows indicated
- Use in conjunction with an appropriate fixing or anchor for the intended base material
- Ensure fixing is suitable for use
- Ensure fixing will couple with 90 degree bracket

CODE	DESCRIPTION	SWL	PACK QTY
ULG1	1 Mtr angle bracket suspension system	15kg	10
ULG2	2 Mtr angle bracket suspension system	15kg	10
ULG3	3 Mtr angle bracket suspension system	15kg	10
ULG4	4 Mtr angle bracket suspension system	15kg	10
ULG5	5 Mtr angle bracket suspension system	15kg	10
ULG10	10 Mtr angle bracket suspension system	15kg	10
ULS1	1 Mtr angle bracket suspension system	50kg	10
ULS2	2 Mtr angle bracket suspension system	50kg	10
ULS3	3 Mtr angle bracket suspension system	50kg	10
ULS4	4 Mtr angle bracket suspension system	50kg	10
ULS5	5 Mtr angle bracket suspension system	50kg	10
ULS10	10 Mtr angle bracket suspension system	50kg	10

Bracket sizes also available

CODE	DESCRIPTION	PACK QTY
HCB2	90 Degree bracket with 6.5mm holes, 1.3mm gauge suitable for S wire	10
HCB3	90 Degree bracket with 10.9mm and 6.5mm holes, 2.0mm gauge suitable for Y wire	10

## SHOT-LOCK



### SUITABLE FOR:

- Concrete slab
- Concrete over metal decking
- Steel Beams
- Suitable for lightweight applications only
- Powder Actuated Tools (PAT)

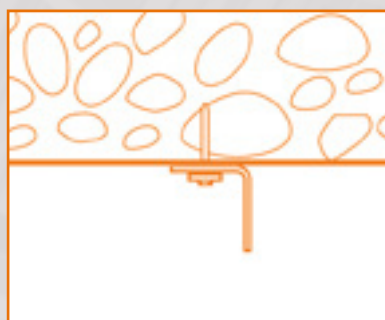
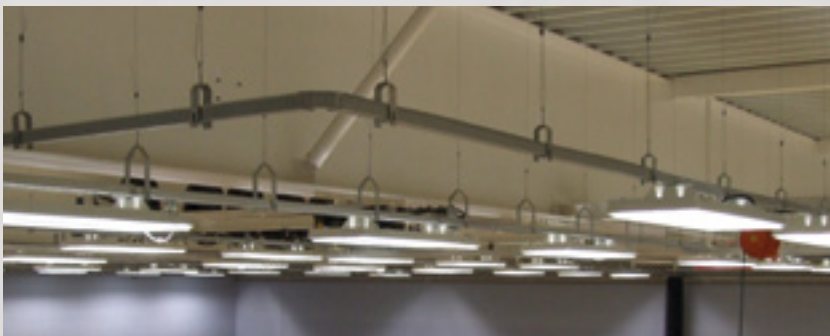

### The Specifics:

The range consists of a pre-determined length of wire from 1 metre to 10 metres with a choice of Safe Working Loads:

- G 15kg
- S 25kg

The system consists of wire and zip-clip device with a shot fire termination complete with a ballistic point.

### The Applications

- Trunking and busbar solutions
- Secondary light support solutions
- Lightweight cable management
- Acoustic ceilings

### The Features and Benefits

- Key free release system
- Available in single or double wire drop
- Eliminates drilling
- Tear drop shape allows for wire to rotate through 180 degrees in bracket for angled applications
- Wire rotation reduces pressure on nail when service is not directly below anchor point
- Ballistic point nail compatible with a range of Powder Actuated Tools (PAT)
  - Hilti DX460
  - Hilti DXA40
  - Hilti DXA41
  - Hilti DX351
  - Spit P200
  - Spit P370
- High tensile galvanised wire 1960 N/mm<sup>2</sup> grade 7 x 7 construction
- BSEN 12385 Standard
- Safety factor: 5:1

## The Installation

- Ensure substrate is suitable for nail and cartridge
- Locate nail into the barrel of the Powder Actuated Tool
- For firing follow the gun manufacturer's guidelines
- Pass the wire through the zip-clip in the direction of the arrow
- Pass through or around your required suspension and back through the zip-clip leaving 15cm of wire protruding
- Always confirm engagement of the zip-clip on the wire by pushing the pin in the opposite direction to the arrows indicated

CODE	DESCRIPTION	SWL	PACK QTY
SLPG1	1 Mtr shot fire suspension system	15kg	10
SLPG2	2 Mtr shot fire suspension system	15kg	10
SLPG3	3 Mtr shot fire suspension system	15kg	10
SLPG4	4 Mtr shot fire suspension system	15kg	10
SLPG5	5 Mtr shot fire suspension system	15kg	10
SLPG10	10 Mtr shot fire suspension system	15kg	10
SLPS1	1 Mtr shot fire suspension system	25kg	10
SLPS2	2 Mtr shot fire suspension system	25kg	10
SLPS3	3 Mtr shot fire suspension system	25kg	10
SLPS4	4 Mtr shot fire suspension system	25kg	10
SLPS5	5 Mtr shot fire suspension system	25kg	10
SLPS10	10 Mtr shot fire suspension system	25kg	10

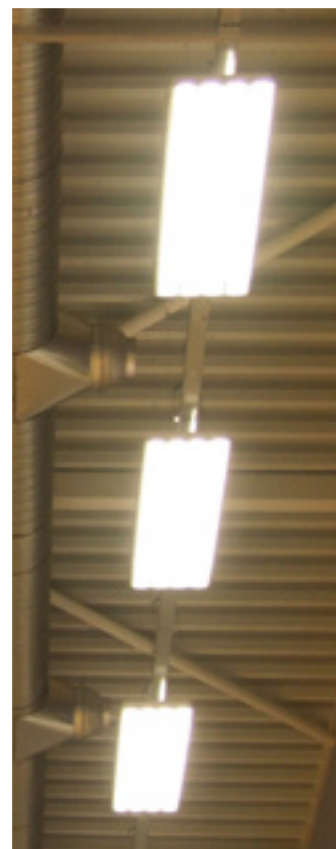

## CHAN-LOCK



### SUITABLE FOR:

- Trapeze bracket solutions – Light duty ONLY

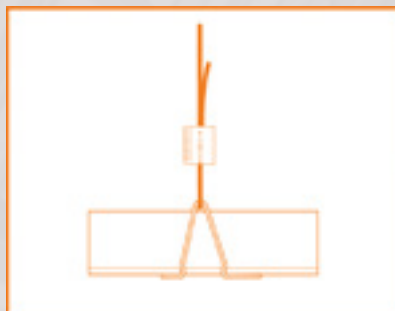
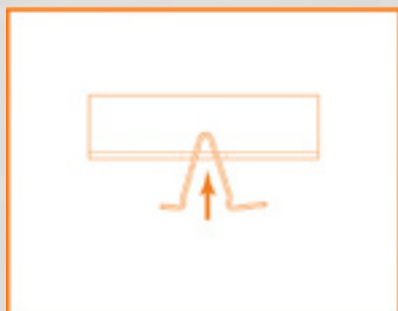

### The Specifics:

The range consists of a pre-determined length of wire from 1 metre to 10 metres with the following Safe Working Load:

- 5 20kg SWL

The system consists of wire, zip-clip device and a push fit Chan-Lock hanger with either a ferruled loop, concrete anchor or M6 eyebolt termination.

### The Applications

- Single tier lightweight trapeze brackets
- Compatible with slotted channel

### The Features and Benefits

- Key free release system
- Galvanised spring metal
- Designed for 41x41 and 41x21 channel
- Short leg to eliminate overhang
- Tool free installation
- Posi-Fit push fit system
- Can be inserted into channel with slots facing either up or down
- Safety factor: 5:1

**System MUST NOT be overloaded**

**Ensure services are loaded evenly**

**DO NOT USE TO SUPPORT ARMoured CABLES**

**NOT FOR DYNAMIC LOADS OR INSTALLATIONS**

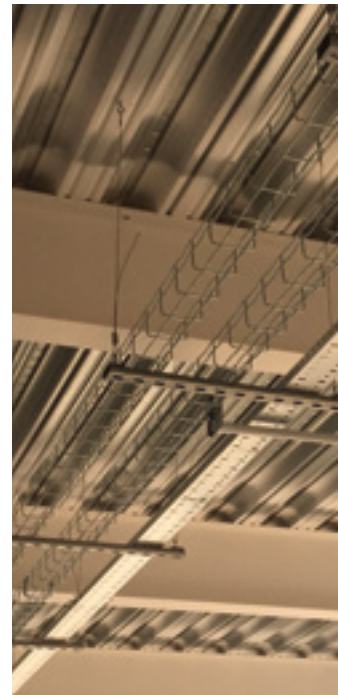

## The Installation

- Simply push the Chan-Lock into the strut, ensuring that the short leg is at the cut end of the channel
- Pass the wire through the zip-clip in the direction of the arrow
- Pass through or around your required suspension and back through the zip-clip leaving 15cm of wire protruding
- Always confirm engagement of the zip-clip on the wire by pushing the pin in the opposite direction to the arrows indicated

CODE	DESCRIPTION	SWL	PACK QTY
CHZ1S	1 Mtr channel loop suspension system	20kg	10
CHZ2S	2 Mtr channel loop suspension system	20kg	10
CHZ3S	3 Mtr channel loop suspension system	20kg	10
CHZ4S	4 Mtr channel loop suspension system	20kg	10
CHZ5S	5 Mtr channel loop suspension system	20kg	10
CHZ10S	10 Mtr channel loop suspension system	20kg	10
CHC1S	1 Mtr channel concrete suspension system	20kg	10
CHC2S	2 Mtr channel concrete suspension system	20kg	10
CHC3S	3 Mtr channel concrete suspension system	20kg	10
CHC4S	4 Mtr channel concrete suspension system	20kg	10
CHC5S	5 Mtr channel concrete suspension system	20kg	10
CHC10S	10 Mtr channel concrete suspension system	20kg	10
CHTR1S/M6X45	1 Mtr channel M6x45 threaded suspension system	20kg	10
CHTR2S/M6X45	2 Mtr channel M6x45 threaded suspension system	20kg	10
CHTR3S/M6X45	3 Mtr channel M6x45 threaded suspension system	20kg	10
CHTR4S/M6X45	4 Mtr channel M6x45 threaded suspension system	20kg	10
CHTR5S/M6X45	5 Mtr channel M6x45 threaded suspension system	20kg	10
CHTR10S/M6X45	10 Mtr channel M6x45 threaded suspension system	20kg	10
CH1	Chan-Lock Push Fit Hanger	20kg	10

## STRUT-LOCK



### SUITABLE FOR:

- Single tier trapeze brackets
- Multi-tier trapeze brackets
- For 41x41 & 41x21 channel
- Can be utilised with other channel types
- Ensure compatible channel nuts are used



### The Specifics:

Strut-Lock is the safe, lockable solution for installing single and multi-tiered arrangements of cable management.

The range consists of a pre determined length of wire from 1 metre to 10 metres with a choice of Safe Working Loads:

- S 45kg – M8
- Y 90kg – M10

### The Applications

- Prefabricated module solutions
- Trapeze bracket solutions – light to medium duty
- Single tier trapeze brackets
- Multi-tier trapeze brackets

### The Features and Benefits

- Versatile: use with channel nut, or nut & washer
- Quick to install and adjust
- SWL: 45kg or 90kg each wire suspension
- Safety factor: 5:1
- Secure lock off
- Material: all steel
- For static loads that are supported vertically

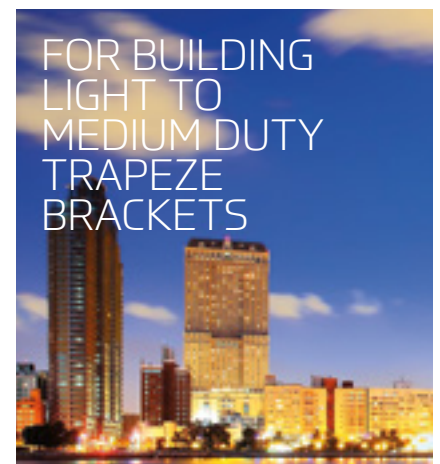



## Fixing Options (into the soffit):

- A) To form a choke knot for wrap around anchor points such as purlins or I-beams. Ensure anchor points are suitable. Product code suffix: TPDM820LP
- B) Concrete anchor BS8539 approved with ETA, offering shallow embedment into cracked & non cracked concrete. Contact Zip Clip for installation details. Product code suffix: TPDM820CS
- C) To couple with female threaded components. Ensure components are compatible to complete the installation. Product code suffix: TPDM820THS

Always ensure the base material or anchor point is suitable to support the intended load.

Other fixing options are available on request.

## The Installation

- Couple Strut-Lock with square washer and channel nut
- Position assembly into desired channel location
- Tighten into position using 15mm spanner. Turn clockwise
- Back off locking collar. Do not undo fully. Depress plunger
- Insert wire rope through the plunger at the top of the device
- Tighten locking collar to lock off



CODE	DESCRIPTION	SWL	PACK QTY
TPDM820	M8 trapeze dome, 45kg SWL	45kg	10
TPDM1020	M10 trapeze dome, 90kg SWL	90kg	10
NM8Z	M8 channel nut		10
WM8S	M8 square plate		10
NM10Z	M10 channel nut		10
WM10S	M10 square plate		10
TPDM820LPS1	1 Mtr standard loop suspension system	45kg	10
TPDM820LPS2	2 Mtr standard loop suspension system	45kg	10
TPDM820LPS3	3 Mtr standard loop suspension system	45kg	10
TPDM820LPS4	4 Mtr standard loop suspension system	45kg	10
TPDM820LPS5	5 Mtr standard loop suspension system	45kg	10
TPDM820LPS10	10 Mtr standard loop suspension system	45kg	10
TPDM820LPY1	1 Mtr standard loop suspension system	90kg	10
TPDM820LPY2	2 Mtr standard loop suspension system	90kg	10
TPDM820LPY3	3 Mtr standard loop suspension system	90kg	10
TPDM820LPY4	4 Mtr standard loop suspension system	90kg	10
TPDM820LPY5	5 Mtr standard loop suspension system	90kg	5
TPDM820LPY10	10 Mtr standard loop suspension system	90kg	5
TPDM820CS1	1 Mtr concrete suspension system	45kg	10
TPDM820CS2	2 Mtr concrete suspension system	45kg	10
TPDM820CS3	3 Mtr concrete suspension system	45kg	10
TPDM820CS4	4 Mtr concrete suspension system	45kg	10
TPDM820CS5	5 Mtr concrete suspension system	45kg	10
TPDM820CS10	10 Mtr concrete suspension system	45kg	10
TPDM820CY1	1 Mtr concrete suspension system	90kg	10
TPDM820CY2	2 Mtr concrete suspension system	90kg	10
TPDM820CY3	3 Mtr concrete suspension system	90kg	10
TPDM820CY4	4 Mtr concrete suspension system	90kg	10
TPDM820CY5	5 Mtr concrete suspension system	90kg	5
TPDM820CY10	10 Mtr concrete suspension system	90kg	5
TPDM820THS1	1 Mtr threaded suspension system	45kg	10
TPDM820THS2	2 Mtr threaded suspension system	45kg	10
TPDM820THS3	3 Mtr threaded suspension system	45kg	10
TPDM820THS4	4 Mtr threaded suspension system	45kg	10
TPDM820THS5	5 Mtr threaded suspension system	45kg	10
TPDM820THS10	10 Mtr threaded suspension system	45kg	10
TPDM820THY1	1 Mtr threaded suspension system	90kg	10
TPDM820THY2	2 Mtr threaded suspension system	90kg	10
TPDM820THY3	3 Mtr threaded suspension system	90kg	10
TPDM820THY4	4 Mtr threaded suspension system	90kg	10
TPDM820THY5	5 Mtr threaded suspension system	90kg	5
TPDM820THY10	10 Mtr threaded suspension system	90kg	5

## PLUS-ON-WIRE



### SUITABLE FOR:

- Trapeze bracket solutions – heavy duty
- Heavy duty single and multi-tier trapeze brackets

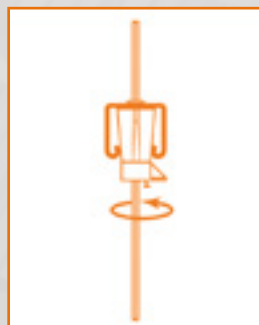
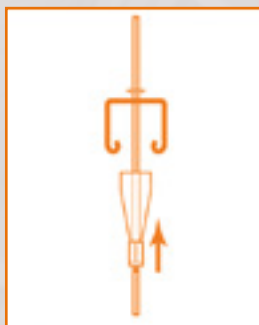
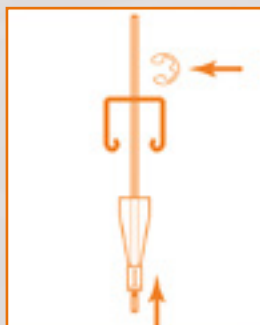

### The Specifics:

The range consists of a pre-determined length of wire with either a loop, concrete anchor or M8 eyebolt.

- 90kg SWL (concrete anchor)
- 100kg SWL (loop or eye fixing)
- Locking C-Clip
- High tensile wire rope 1-10m
- Red safety cap

The system consists of wire and plus clip with either a loop, concrete anchor or M8 eyebolt termination.

### The Applications

- 2D or 3D Modular Systems
- Prefabricated module solutions

### The Features and Benefits

- Key free release. No tools required
- Flexible, ideal if anchor point is not straight above
- Easy to cut
- Speed of installation
- Fully lockable into slotted channel
- Zamac 5 housing incorporating oil impregnated sintered steel wedge
- High tensile galvanised wire 1960N/mm<sup>2</sup> grade 7 x 7 construction
- BSEN 12385 Standard
- Safety factor: 5:1

## The Installation

- Loop, screw or drill your end into or around your chosen anchor point
- Position Plus Clip into channel and slide the wire through the clip
- To adjust release the load from the Plus Clip by pushing the clip up the wire
- Then pull down on the release key at the same time

CODE	DESCRIPTION	SWL	PACK QTY
PLR1	1 Mtr loop suspension system	100kg	10
PLR2	2 Mtr loop suspension system	100kg	10
PLR3	3 Mtr loop suspension system	100kg	10
PLR4	4 Mtr loop suspension system	100kg	10
PLR5	5 Mtr loop suspension system	100kg	5
PLR10	10 Mtr loop suspension system	100kg	5
PLR1C	1 Mtr concrete suspension system	90kg	10
PLR2C	2 Mtr concrete suspension system	90kg	10
PLR3C	3 Mtr concrete suspension system	90kg	10
PLR4C	4 Mtr concrete suspension system	90kg	10
PLR5C	5 Mtr concrete suspension system	90kg	5
PLR10C	10 Mtr concrete suspension system	90kg	5
PLR1E8	1 Mtr M8x60 threaded suspension system	100kg	10
PLR2E8	2 Mtr M8x60 threaded suspension system	100kg	10
PLR3E8	3 Mtr M8x60 threaded suspension system	100kg	10
PLR4E8	4 Mtr M8x60 threaded suspension system	100kg	10
PLR5E8	5 Mtr M8x60 threaded suspension system	100kg	5
PLR10E8	10 Mtr M8x60 threaded suspension system	100kg	5
PLU02	Plus Clip	100kg	10

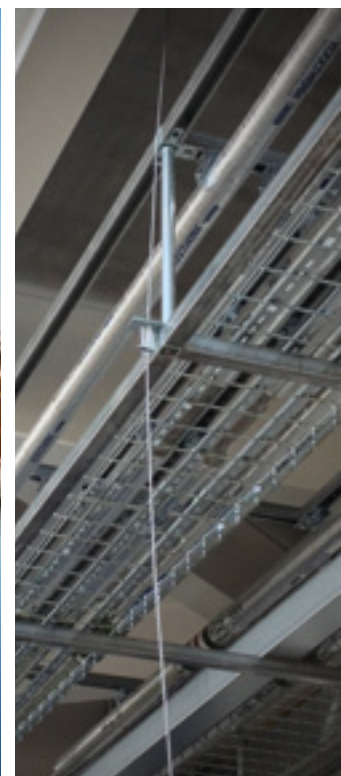

## TRY-LOCK



### SUITABLE FOR:

- Cable basket solutions
- Cable tray solutions
- Long suspensions

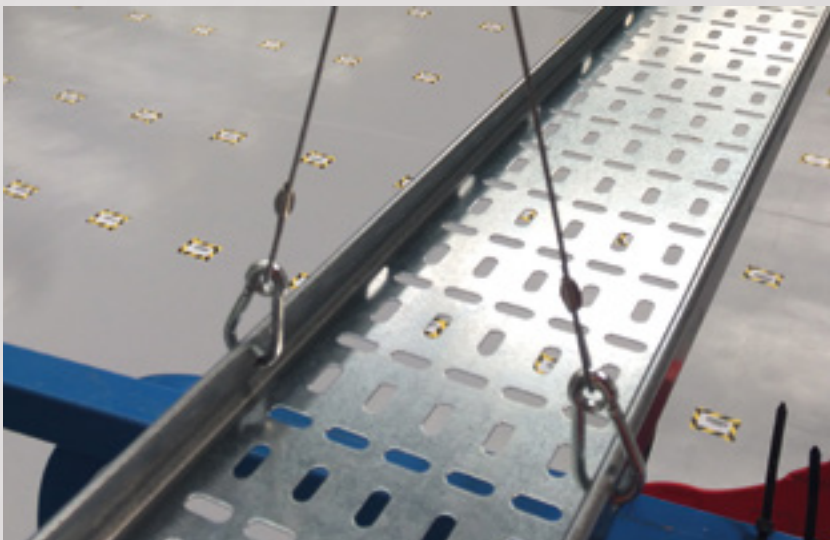

### The Specifics:

The range consists of two pre-determined lengths of wire to support basket and tray with the following Safe Working Load:

- 50kg

Designed to be used in conjunction with Rize, Zip-Lock, Loop-It, Con-Lock, Dec-Lock, Shot-Lock and Uni-Lock.

### The Applications

Suitable for suspending containment and bracketry:

- Channel supports
- Cable basket
- Cable tray
- Channel supports

### The Features and Benefits

- Reduces the use of studding and channel
- One fixing point per drop
- Ensures services are level
- Allows for side loading
- Height can be adjusted at basket and not at fixing
- Can be fixed to basket at ground level
- Plastic protection sleeve preventing wire on wire friction
- 5 x 50 BZP carabiner hook
- Eyelets prevent accidental un-hooking of carabiner from wire
- High tensile galvanised wire 1960 N/mm<sup>2</sup> grade 7 x 7 construction
- BSEN 12385 Standard
- Safety factor: 5:1

# TRY-LOCK

## The Installation

- The attachment of the Try-Lock system can be done at ground level
- Clip the carabiner to one side of the product to be suspended
- Clip the other carabiner to the other side of the product to be suspended
- Pass the free end of the wire from your top suspension through the zip-clip in the direction of the arrow
- Pass through the plastic protected loop of the Try-Lock and back through the zip-clip leaving 15cm of wire protruding
- Always confirm engagement of the zip-clip on the wire by pushing the pin in the opposite direction to the arrows indicated
- Legs should not exceed 60 degrees

CODE	DESCRIPTION	SWL	PACK QTY
TRS50-200	Eyelet carabiner suspension system suitable for spans of 50-200mm	50kg	10
TRS300-400	Eyelet carabiner suspension system suitable for spans of 300-400mm	50kg	10



FOR SUPPORTING  
INDIVIDUAL SERVICE RUNS



Y-IT



SUITABLE FOR:

- Cable basket solutions – Carabiner
- Cable tray solutions – Toggle
- Lighting fittings
- Installing in small voids

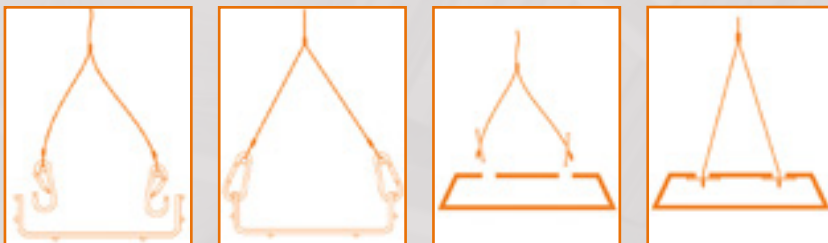

The Specifics:

The range consists of a pre-determined length of wire from 1 metre to 3 metres with a choice of Safe Working Loads:

Carabiner end:

- S 50kg SWL
- Y 90kg WL

Toggle end:

- G 15kg SWL
- S 35kg SWL
- Y 90kg SWL

The system consists of a pre-determined length of wire with a second ferruled leg and a choice of either carabiner or toggle ends.

The Applications

Carabiner end:

- Channel supports
- Cable basket
- Cable tray

Toggle end:

- Lighting fixings
- Basket, ladder and tray

The Features and Benefits

- Key free release system
- High tensile galvanised wire 1960N/mm<sup>2</sup> grade 7 x 7 construction
- BSEN 12385 standard
- One fixing point per drop
- Allows for side loading
- Can be fixed at ground level
- Reduces the use of studding and channel
- Ideal for short suspensions
- Ensures services hang level
- Safety factor: 5:1

## The Installation

Installing the carabiners:

- Clip one carabiner to one side of the product to be suspended
- Clip the other carabiner to the other side of the product to be suspended

Installing the toggles:

- Attach the two toggles to the system being suspended
- By inverting the toggle parallel to the wire the toggle will swing through 90 degrees
- Ensure hole is no larger than 12mm diameter
- Pass the free end of the wire through the zip-clip in the direction of the arrow
- Pass through or around your required suspension point and back through the zip-clip leaving 15cm of wire protruding
- Always confirm engagement of the zip-clip on the wire by pushing the pin in the opposite direction to the arrows indicated

CODE	DESCRIPTION	SWL	PACK QTY
YTR1S/300	1 Mtr x 300mm eyelet carabiner suspension system	50kg	10
YTR2S/300	2 Mtr x 300mm eyelet carabiner suspension system	50kg	10
YTR3S/300	3 Mtr x 300mm eyelet carabiner suspension system	50kg	10
YTR1S/460	1 Mtr x 460mm eyelet carabiner suspension system	50kg	10
YTR2S/460	2 Mtr x 460mm eyelet carabiner suspension system	50kg	10
YTR3S/460	3 Mtr x 460mm eyelet carabiner suspension system	50kg	10
YTR1Y/300	1 Mtr x 300mm eyelet carabiner suspension system	90kg	10
YTR2Y/300	2 Mtr x 300mm eyelet carabiner suspension system	90kg	10
YTR3Y/300	3 Mtr x 300mm eyelet carabiner suspension system	90kg	10
YTR1Y/460	1 Mtr x 460mm eyelet carabiner suspension system	90kg	10
YTR2Y/460	2 Mtr x 460mm eyelet carabiner suspension system	90kg	10
YTR3Y/460	3 Mtr x 460mm eyelet carabiner suspension system	90kg	10
YLM1G/300	1 Mtr x 300mm toggle suspension system	15kg	10
YLM2G/300	2 Mtr x 300mm toggle suspension system	15kg	10
YLM3G/300	3 Mtr x 300mm toggle suspension system	15kg	10
YLM1G/600	1 Mtr x 600mm toggle suspension system	15kg	10
YLM2G/600	2 Mtr x 600mm toggle suspension system	15kg	10
YLM3G/600	3 Mtr x 600mm toggle suspension system	15kg	10
YLM1S/300	1 Mtr x 300mm toggle suspension system	35kg	10
YLM2S/300	2 Mtr x 300mm toggle suspension system	35kg	10
YLM3S/300	3 Mtr x 300mm toggle suspension system	35kg	10
YLM1S/460	1 Mtr x 460mm toggle suspension system	35kg	10
YLM2S/460	2 Mtr x 460mm toggle suspension system	35kg	10
YLM3S/460	3 Mtr x 460mm toggle suspension system	35kg	10
YLM1Y/300	1 Mtr x 300mm toggle suspension system	90kg	10
YLM2Y/300	2 Mtr x 300mm toggle suspension system	90kg	10
YLM3Y/300	3 Mtr x 300mm toggle suspension system	90kg	10
YLM1Y/460	1 Mtr x 460mm toggle suspension system	90kg	10
YLM2Y/460	2 Mtr x 460mm toggle suspension system	90kg	10
YLM3Y/460	3 Mtr x 460mm toggle suspension system	90kg	10

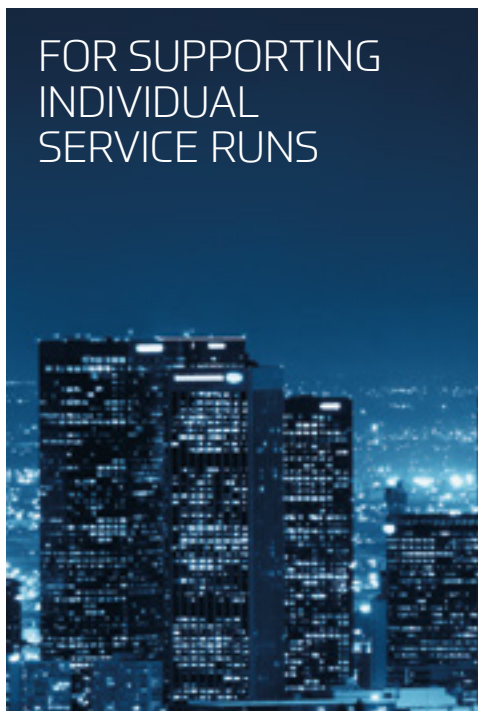

FOR SUPPORTING  
INDIVIDUAL  
SERVICE RUNS



## LUMA-LOCK

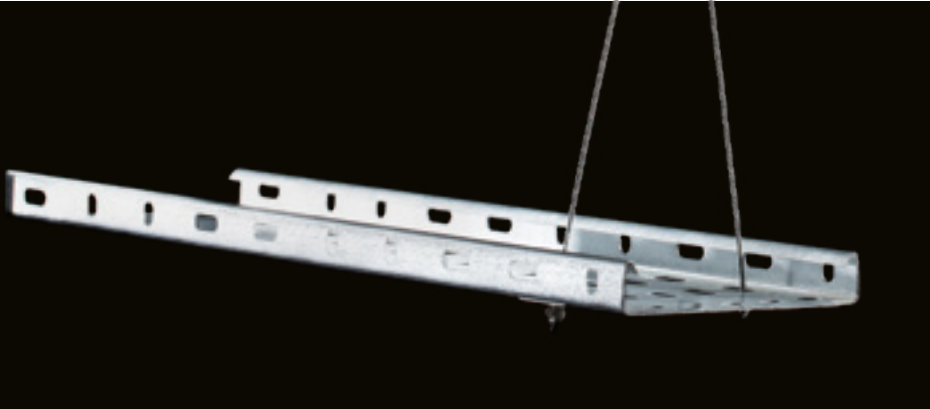

### SUITABLE FOR:

- Cable tray solutions
- Long suspensions
- Lighting fittings

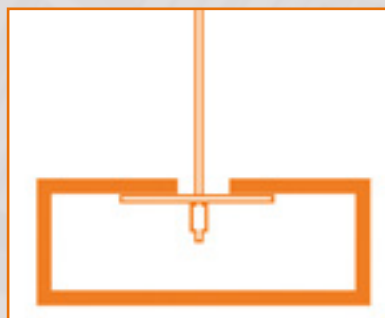
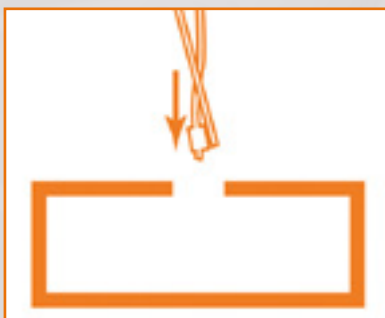

### The Specifics:

The range consists of pre-determined lengths of wire for the installation of primary and secondary installations with a choice of Safe Working Loads:

- G 15kg SWL
- S 35kg SWL

Designed to be used in conjunction with Rize, Zip-Lock, Con-Lock, Dec-Lock, Shot-Lock and Uni-Lock.

### The Applications

Suitable for primary and secondary support for suspending:

- Cable trays
- Lighting fittings
- Cable tray

### The Features and Benefits

- Reduces the use of studding and channel
- One fixing point per drop
- Can be fixed to installation at ground level
- High tensile galvanised wire 1960N/mm<sup>2</sup> grade 7 x 7 construction
- BSEN 12385 Standard
- Safety factor: 5:1

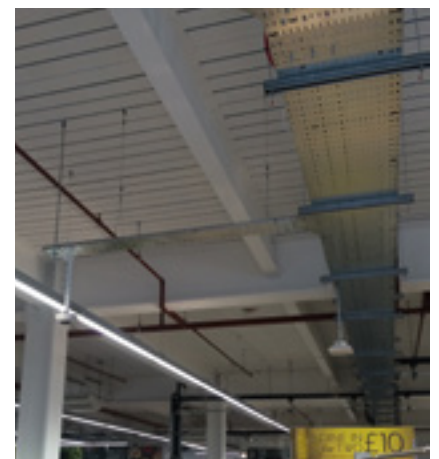



## The Installation

- The attachment of the Luma-Lock system can be done at ground level
- Attach the two toggles to the system being suspended
- By inverting the toggle parallel to the wire the toggle will swing through 90 degrees
- Ensure hole is no larger than 12mm diameter
- Pass the free end of the wire from your top suspension through the zip-clip in the direction of the arrow
- Pass through the plastic protected loop of the Luma-Lock and back through the zip-clip leaving 15cm of wire protruding
- Always confirm engagement of the zip-clip on the wire by pushing the pin in the opposite direction to the arrows indicated
- Legs should not exceed 60 degrees

CODE	DESCRIPTION	SWL	PACK QTY
LUMG50-200	Toggle suspension system suitable for spans of 50-200mm	15kg	10
LUMG300-400	Toggle suspension system suitable for spans of 300-400mm	15kg	10
LUMG600	Toggle suspension system suitable for spans of 600mm	15kg	10
LUM50-200	Toggle suspension system suitable for spans of 50-200mm	35kg	10
LUM300-400	Toggle suspension system suitable for spans of 300-400mm	35kg	10
LUM600	Toggle suspension system suitable for spans of 600mm	35kg	10



## ARCHITECTURAL Y-HANGER



### SUITABLE FOR:

- Decorative and aesthetical
- Lighting systems
- Signage systems
- Light weight systems



### The Specifics:

Architectural support used to create an inverted Y Shape wire support. Ideal for fixtures with wide fixing centres.

- G 15kg SWL

### The Applications

- Lighting fittings
- Cable tray solutions

### The Features and Benefits

- To be used in conjunction with toggles
- Allows for one single suspension point from the ceiling
- Ensures service hangs level
- Available with side exit which allows for height adjustment at service level
- Fully lockable for safety
- Can be supplied with a variety of ceiling fixings
- Available in kit format: lengths from 1-3 metres
- Requires 2.5mm hex key to adjust toggle legs
- Length 37.0mm
- Diameter 9.0mm
- Slit width 2mm
- Safety factor: 5:1

# ARCHITECTURAL Y-HANGER

## The Installation

- Unscrew lockable plunger anti clockwise allowing it to actuate. Do not unscrew fully
- Feed vertical wire support through top of the plunger until it appears at the side exit
- Pull wire through side exit allowing a tail of 75mm minimum
- Now screw lockable plunger clockwise to lock off the device

### Levelling the fixture:

- Use a 2.5mm hex key bit to loosen the grub screw located in the base of the device. Do not unscrew fully
- Move inverted Y shape wire until fixture is level
- Tighten grub screw clockwise to lock Y shape wire into place. Do not over tighten

CODE	DESCRIPTION	SWL	PACK QTY
AC3WAY	3 way architectural support	15kg	10
ACSL3W1G/300LM	1 Mtr 3 way support with architectural fixing 300mm legs	15kg	10
ACSL3W2G/300LM	2 Mtr 3 way support with architectural fixing 300mm legs	15kg	10
ACSL3W3G/300LM	3 Mtr 3 way support with architectural fixing 300mm legs	15kg	10
ACPLCAK3W1G/300LM	1 Mtr 3 way support with concrete fixing 300mm legs	15kg	10
ACPLCAK3W2G/300LM	2 Mtr 3 way support with concrete fixing 300mm legs	15kg	10
ACPLCAK3W3G/300LM	3 Mtr 3 way support with concrete fixing 300mm legs	15kg	10
ACPLEK3W1G/300LM	1 Mtr 3 way support with loop fixing 300mm legs	15kg	10
ACPLEK3W2G/300LM	2 Mtr 3 way support with loop fixing 300mm legs	15kg	10
ACPLEK3W3G/300LM	3 Mtr 3 way support with loop fixing 300mm legs	15kg	10



## M6 MALE ARCHITECTURAL SUPPORT



### SUITABLE FOR:

- Decorative and aesthetical
- Lighting systems
- Signage systems
- Light weight systems
- Attaching to M6 female threads



### The Specifics:

Designed for lightweight fixtures or fittings with a M6 female thread. Ideal for installing into lighting track.

- G 15kg SWL

### The Applications

- Lighting fittings
- Cable tray solutions

### The Features and Benefits

- Available with side exit allowing for height adjustment at fixture level
- Fully lockable for safety
- Can be supplied with a variety of ceiling fixings
- Available in kit format: lengths from 1-3 metres
- Length 43.0mm
- Diameter 8.9mm
- Thread dia. M6 – M5 also available on request
- Safety factor: 5:1

# M6 MALE ARCHITECTURAL SUPPORT

IDEAL FOR INSTALLING INTO LIGHTING TRACK



## The Installation

- Fully screw male thread clockwise into female thread Or,
- Pass male thread into a “through hole” and use integral nut and washer to lock into place
- Unscrew lockable plunger anti clockwise allowing it to actuate. Do not unscrew fully
- Feed vertical wire support through top of the plunger until it appears at the side exit
- Pull wire through side exit allowing a tail of 75mm minimum
- Now screw lockable plunger clockwise to lock off the device

CODE	DESCRIPTION	SWL	PACK QTY
ACMGM6S	M6 Male architectural support	15kg	10
ACSLM6MS1G	1 Mtr single lighting suspension male thread M6 – architectural end	15kg	10
ACSLM6MS2G	2 Mtr single lighting suspension male thread M6 – architectural end	15kg	10
ACSLM6MS3G	3 Mtr single lighting suspension male thread M6 – architectural end	15kg	10
ACPLCAKM6MS1G	1 Mtr single lighting suspension male thread M6 – concrete end	15kg	10
ACPLCAKM6MS2G	2 Mtr single lighting suspension male thread M6 – concrete end	15kg	10
ACPLCAKM6MS3G	3 Mtr single lighting suspension male thread M6 – concrete end	15kg	10
ACPLEKM6MS1G	1 Mtr single lighting suspension male thread M6 – loop end	15kg	10
ACPLEKM6MS2G	2 Mtr single lighting suspension male thread M6 – loop end	15kg	10
ACPLEKM6MS3G	3 Mtr single lighting suspension male thread M6 – loop end	15kg	10

## M10 MALE ARCHITECTURAL SUPPORT



### SUITABLE FOR:

- Decorative and aesthetical
- Lighting systems
- Signage systems
- Light weight systems
- Attaching to M10 female threads



### The Specifics:

Designed for lightweight fixtures or fittings with a M10 female thread. Ideal for installing into recessed lights.

- G 15kg SWL

### The Applications

- Lighting fittings
- Cable tray solutions

### The Features and Benefits

- Available with through exit allowing for height adjustment at fixture level
- Bottom exit
- Fully threaded body leaves low profile once installed
- Fully lockable for safety
- Can be supplied with a variety of ceiling fixings
- Available in kit format: lengths from 1-3 metres
- Length 25.7mm
- Diameter 10.0mm
- Thread dia. M10
- Safety factor: 5:1

# M10 MALE ARCHITECTURAL SUPPORT

## The Installation

- Fully screw male thread clockwise into female thread Or,
- Pass male thread into a “through hole” and use integral nut and washer to lock into place
- Unscrew lockable plunger anti clockwise allowing it to actuate. Do not unscrew fully
- Feed vertical wire support through top of the plunger  
Please note: through exit directs wire into your fixture. Ensure fixture will accommodate redundant wire
- Push a minimum of 75mm of wire through the device before locking off
- Now screw lockable plunger clockwise to lock off the device

CODE	DESCRIPTION	SWL	PACK QTY
ACMGM10B	M10 Male architectural support	15kg	10
ACSLM10MB1G	1 Mtr single lighting suspension male thread M10 – architectural end	15kg	10
ACSLM10MB2G	2 Mtr single lighting suspension male thread M10 – architectural end	15kg	10
ACSLM10MB3G	3 Mtr single lighting suspension male thread M10 – architectural end	15kg	10
ACPLCAKM10MB1G	1 Mtr single lighting suspension male thread M10 – concrete end	15kg	10
ACPLCAKM10MB2G	2 Mtr single lighting suspension male thread M10 – concrete end	15kg	10
ACPLCAKM10MB3G	3 Mtr single lighting suspension male thread M10 – concrete end	15kg	10
ACPLEKM10MB1G	1 Mtr single lighting suspension male thread M10 – loop end	15kg	10
ACPLEKM10MB2G	2 Mtr single lighting suspension male thread M10 – loop end	15kg	10
ACPLEKM10MB3G	3 Mtr single lighting suspension male thread M10 – loop end	15kg	10



## ARCHITECTURAL SUPPORT WITH M6 FEMALE THREAD



### SUITABLE FOR:

- Decorative and aesthetical
- Lighting systems
- Signage systems
- Light weight systems
- Attaching to M6 male threads



### The Specifics:

Versatile fitting designed to attach to lightweight fixtures or fittings with a M6 male thread.

- G 15kg SWL

### The Applications

- Lighting fittings
- Cable tray solutions

### The Features and Benefits

- Available with side exit which allows for height adjustment at fixture level
- Fully lockable for safety
- Can be supplied with a variety of different ceiling fixings
- Can be inverted to attach to the ceiling with an M6 stud. Allows for height adjustment at ceiling or service level
- Can be utilised with a bolt & washer to clamp onto an M6 through hole
- Available in kit format: lengths from 1-3 metres
- Length 35mm
- Diameter 9mm
- Hole Depth: 7mm
- Safety factor: 5:1



## ARCHITECTURAL SUPPORT WITH M6 FEMALE THREAD

### The Installation

- If installing into a fixture, screw locking device clockwise onto suitable M6 male thread until tight. Male thread must be 7.0mm minimum
- If installing into the ceiling, first ensure a suitable fixing has been installed with a M6 thread eg – dual threaded bolt. Screw locking device clockwise onto the male thread until tight
- Attach device onto M6 through hole using M6 bolt and washer. Screw bolt clockwise ensuring it is tight

CODE	DESCRIPTION	SWL	PACK QTY
ACFGM6S	M6 Female architectural support	15kg	10
ACSLM6FS1G	1 Mtr single lighting suspension female thread M6 – architectural end	15kg	10
ACSLM6FS2G	2 Mtr single lighting suspension female thread M6 – architectural end	15kg	10
ACSLM6FS3G	3 Mtr single lighting suspension female thread M6 – architectural end	15kg	10
ACPLCAKM6FS1G	1 Mtr single lighting suspension female thread M6 – concrete end	15kg	10
ACPLCAKM6FS2G	2 Mtr single lighting suspension female thread M6 – concrete end	15kg	10
ACPLCAKM6FS3G	3 Mtr single lighting suspension female thread M6 – concrete end	15kg	10
ACPLEKM6FS1G	1 Mtr single lighting suspension female thread M6 – loop end	15kg	10
ACPLEKM6FS2G	2 Mtr single lighting suspension female thread M6 – loop end	15kg	10
ACPLEKM6FS3G	3 Mtr single lighting suspension female thread M6 – loop end	15kg	10



VERSATILE  
FITTING  
DESIGNED TO  
ATTACH TO  
LIGHTWEIGHT  
FIXTURES OR  
FITTINGS

## M6 CEILING FIXING WITH SLOT



### SUITABLE FOR:

- Attaching wire support to the ceiling with the use of an appropriate fixing
- Angled wire suspensions
- Decorative and aesthetical



### The Specifics:

Architectural ceiling fixing designed to give a sleek tidy attachment to the soffit. Can be fitted to a ceiling or fixture and used in conjunction with the Zip-Clip range of architectural supports:

- G 15kg SWL

### The Applications

- Lighting
- Signage
- Lightweight containment

### The Features and Benefits

- Two part fitting consisting of:
  1. M6 Female threaded base plate
  2. Internally threaded dome cover to encapsulate the wire support
- Low visual impact
- Slot allows rotation of the wire through an angle (max 60 degrees)
- Base plate can be fixed to the ceiling using M6:
  - Dual threaded screw with M6 stud
  - Wood screw
  - Concrete screw
  - Plug and screw
- Base plate and cover marry together to form one complete fitting with the same diameter
- Safety factor: 5:1

## M6 CEILING FIXING WITH SLOT



ARCHITECTURAL CEILING  
FIXING DESIGNED TO GIVE  
A SLEEK TIDY ATTACHMENT  
TO THE SOFFIT.



### The Installation

- Disassemble base plate by turning anticlockwise
- Fix base plate to ceiling using desired fixing
- Ensure wire is correctly set inside the dome
- Screw dome onto base plate by turning clockwise
- Ensure dome is secure

CODE	DESCRIPTION	SWL	PACK QTY
ACSL0TM6	M6 dome ceiling attachment	15kg	10
ACSL1G	1 Mtr single dome suspension M6	15kg	10
ACSL2G	2 Mtr single dome suspension M6	15kg	10
ACSL3G	3 Mtr single dome suspension M6	15kg	10

## BARREL CEILING FIXING



### SUITABLE FOR:

- Attaching wire support to the ceiling with the use of an appropriate fixing
- Decorative and aesthetical



### The Specifics:

Architectural ceiling fixing designed to give a sleek tidy attachment to the soffit. Can be fitted to a ceiling or fixture and used in conjunction with the Zip-Clip range of architectural supports:

- G 15kg SWL

### The Applications

- Lighting
- Signage
- Lightweight containment

### The Features and Benefits

- Two part fitting consisting of:
  1. Base plate with 4.4mm through hole (not threaded)
  2. Internally threaded dome cover to encapsulate the wire support
- Low visual impact
- Base plate can be fixed to the ceiling using countersunk fixing:
  - Wood screw
  - Concrete screw
  - Plug and screw
- Base plate and cover marry together to form one complete fitting with the same diameter
- Safety factor: 5:1

## BARREL CEILING FIXING

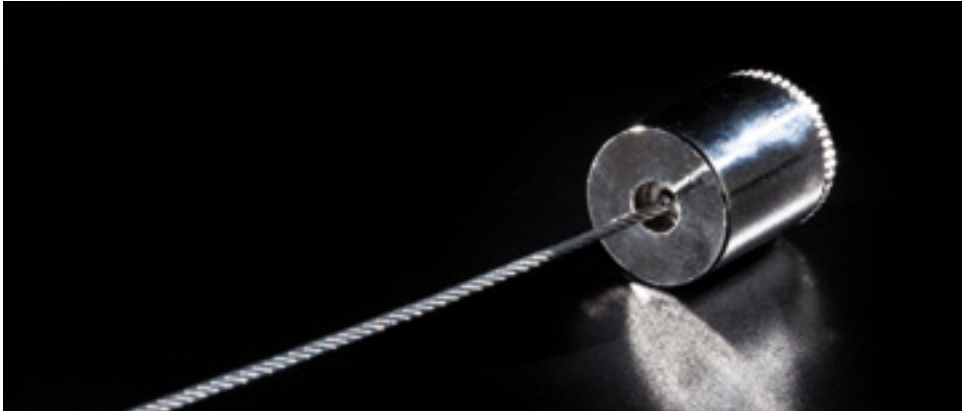

CAN BE FITTED TO A CEILING OR FIXTURE AND USED IN CONJUNCTION WITH THE ZIP-CLIP RANGE OF ARCHITECTURAL SUPPORTS

### The Installation

- Disassemble base plate by turning anticlockwise
- Fix barrel to ceiling using the desired fixing
- Ensure the wire is correctly located in the male threaded insert
- Screw the insert into the barrel by turning clockwise
- Ensure the insert is secured and finger tight using the knurled edge

CODE	DESCRIPTION	SWL	PACK QTY
ACBPLATE	M6 Barrel ceiling attachment	15kg	10
ACBPL1G	1 Mtr single base plate suspension M6	15kg	10
ACBPL2G	2 Mtr single base plate suspension M6	15kg	10
ACBPL3G	3 Mtr single base plate suspension M6	15kg	10

## BLACK-LOCK

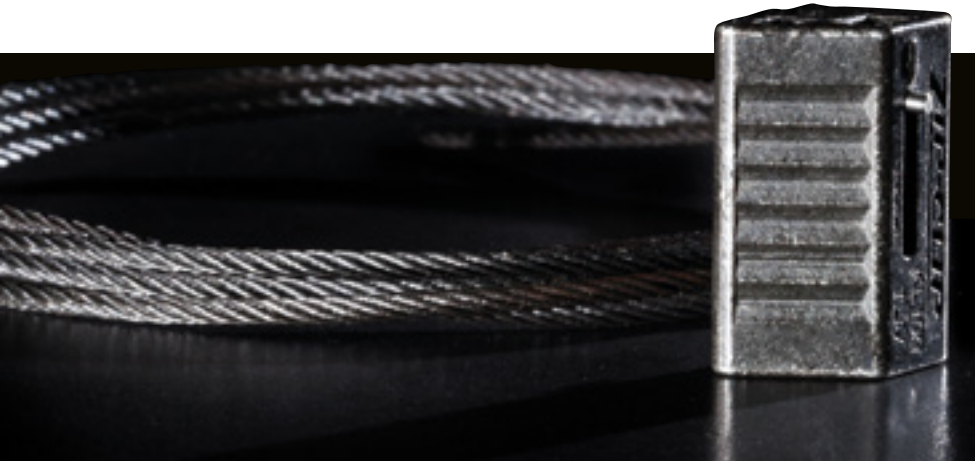

### SUITABLE FOR:

- Cafés
- Theatres
- Cinemas
- Retail
- Aesthetical
- Decorative



### The Specifics:

Wire suspension systems which are available in black for installations that require blending in with surroundings and offering extra discretion.

- 5 45kg SWL

### The Applications

- Cable tray solutions
- Cable basket solutions
- Lighting fittings

### The Features and Benefits

- Process involves a surface conversion in order to colour the wire suspensions
- Aluminium components of the wire suspensions are galvanised colour
- Safety factor: 5:1

## The Installation

- Cut wire to desired length for the drop required
- Pass one end of the wire through the zip-clip in the direction of the arrow and draw through enough wire to go around your fixing point
- Pass the wire end back through the zip-clip leaving at least 15cm of free wire protruding
- At the other end again pass the wire through the zip-clip in the direction of the arrow
- Pass the free end of wire around your suspension or through your fixing and back through the zip-clip leaving 15cm of wire protruding
- Always confirm engagement of the zip-clip on the wire by pushing the pin in the opposite direction to the arrows indicated

**Please contact the Zip-Clip offices for details on the full Black-Lock range**

CODE	DESCRIPTION	SWL	PACK QTY
BLK/KL100	Rize KL100 Black 45kg SWL	45kg	10
BLK/R100S	100 Mtr S Black Wire Rope	45kg	10

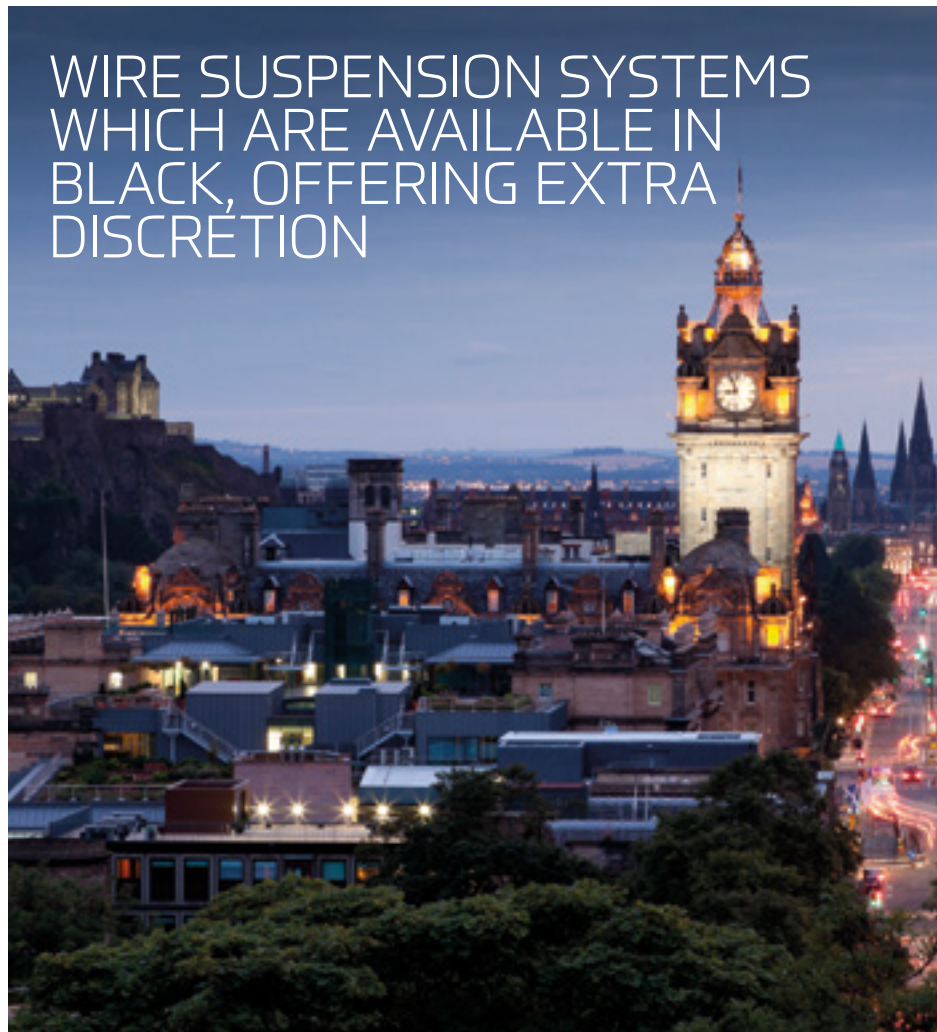

## ZIP-GRIP

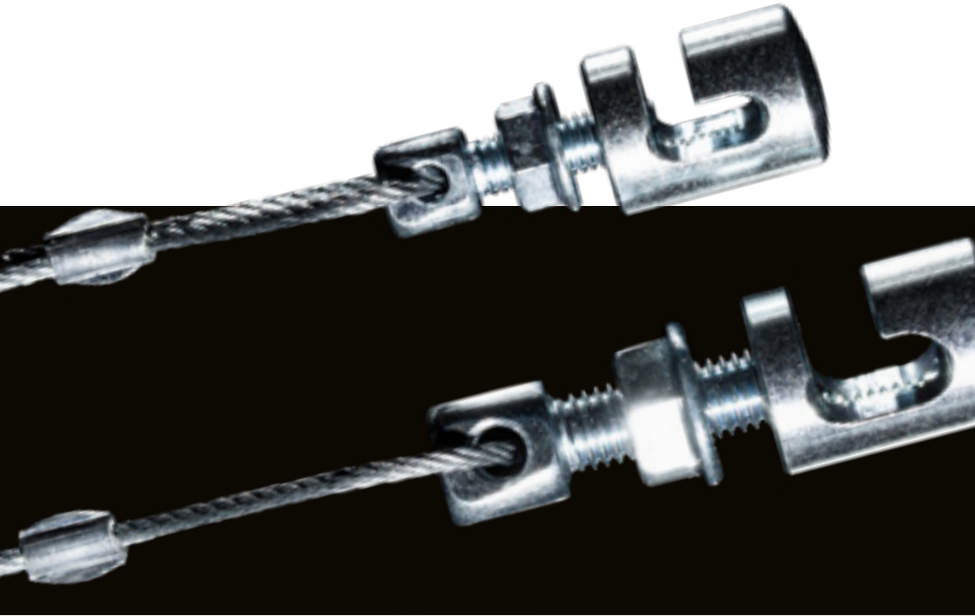

### The Specifics:

Zip-Grip and Span-Lock are designed to be used in conjunction so as to create a complete catenary system. Zip-Grip is available in 1 to 10 metre lengths, with a choice of Safe Working Loads:

- G 15kg SWL
- S 35kg SWL

Available in M6 to fit Y and P Span-lock range and M8 to fit the N range.

### SUITABLE FOR:

- Catenary solutions
- Linking a service to a catenary wire



### The Applications

- Lighting
- Lighting trunking
- Busbar
- Lightweight cable management

### The Features and Benefits

- Key free release system
- Simple hook and lock system
- Ability to suspend many products, even at angles
- Easy slide for adjustment into final position
- Can be fitted retrospectively
- Can be inverted to offer extra support to the Span-Lock range
- Suitable for applications where no overhead fixing points are available
- Safety factor: 5:1

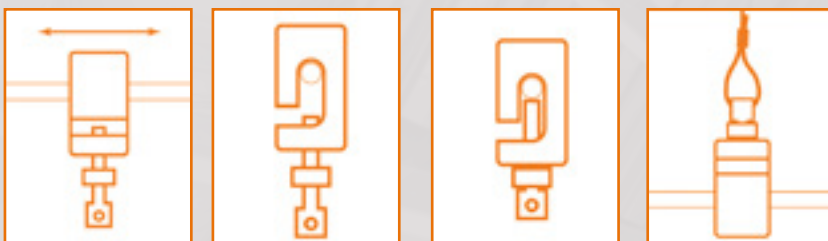





**ZIP-GRIP IS  
DESIGNED TO  
BE USED IN  
CONJUNCTION  
WITH  
SPAN-LOCK  
TO CREATE A  
COMPLETE  
CATENARY  
SUPPORT**

## The Installation

- Place the Zip-Grip onto the tightened horizontal catenary wire and slide into place
- Tighten the eyebolt until engaged on the Span-Lock wire, then tighten the locking nut to secure in place
- Pass the free end of the wire through the supplied zip-clip around the object to be suspended then back through the zip-clip
- Pass the wire through the zip-clip in the direction of the arrow
- Pass through or around your required suspension and back through the zip-clip leaving 15cm of wire protruding
- Height can then be adjusted
- To reduce deflection in the wire the Zip-Grip can be inverted and fixed to the structure above
- Always confirm engagement of the zip-clip on the wire by pushing the pin in the opposite direction to the arrows indicated

CODE	DESCRIPTION	SWL	PACK QTY
GLG1	1 Mtr vertical suspension system M6	15kg	10
GLG2	2 Mtr vertical suspension system M6	15kg	10
GLG3	3 Mtr vertical suspension system M6	15kg	10
GLG4	4 Mtr vertical suspension system M6	15kg	10
GLG5	5 Mtr vertical suspension system M6	15kg	10
GLG10	10 Mtr vertical suspension system M6	15kg	10
GLS1	1 Mtr vertical suspension system M6	35kg	10
GLS2	2 Mtr vertical suspension system M6	35kg	10
GLS3	3 Mtr vertical suspension system M6	35kg	10
GLS4	4 Mtr vertical suspension system M6	35kg	10
GLS5	5 Mtr vertical suspension system M6	35kg	10
GLS10	10 Mtr vertical suspension system M6	35kg	10
GLG1/M8	1 Mtr vertical suspension system M8	15kg	10
GLG2/M8	2 Mtr vertical suspension system M8	15kg	10
GLG3/M8	3 Mtr vertical suspension system M8	15kg	10
GLG4/M8	4 Mtr vertical suspension system M8	15kg	10
GLG5/M8	5 Mtr vertical suspension system M8	15kg	10
GLG10/M8	10 Mtr vertical suspension system M8	15kg	10
GLS1/M8	1 Mtr vertical suspension system M8	35kg	10
GLS2/M8	2 Mtr vertical suspension system M8	35kg	10
GLS3/M8	3 Mtr vertical suspension system M8	35kg	10
GLS4/M8	4 Mtr vertical suspension system M8	35kg	10
GLS5/M8	5 Mtr vertical suspension system M8	35kg	10
GLS10/M8	10 Mtr vertical suspension system M8	35kg	10

## SPAN-LOCK

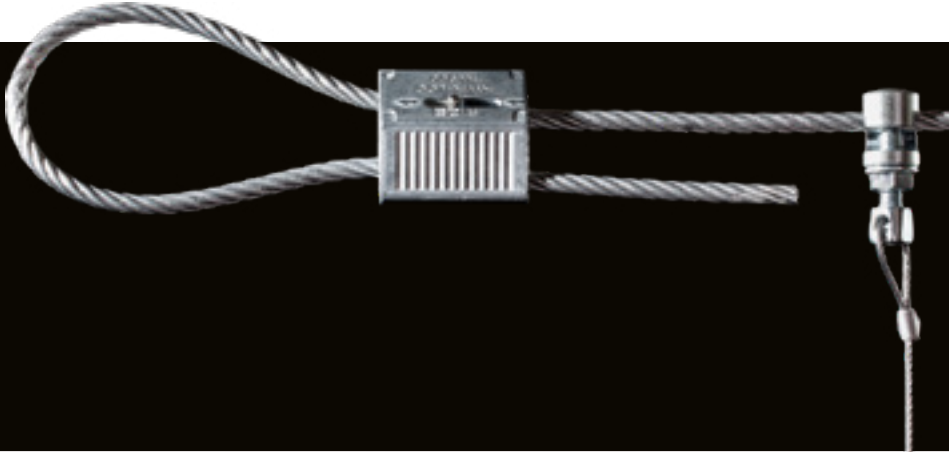

### SUITABLE FOR:

- Catenary solutions
- Supporting cables above suspended ceilings



### The Specifics:

Span-Lock and Zip-Grip are designed to be used in conjunction so as to create a complete catenary system. Span-Lock is available in 5, 10, 15, 20, 30 and 40 metre lengths, with a choice of Safe Working Loads:

- Y 30kg SWL
- P 75kg SWL
- N 100kg SWL

### The Applications

- 18th Edition cable management
- Lighting and lighting track
- Lighting trunking
- Busbar
- Lightweight electrical containment

### The Features and Benefits

- Key free release system
- Designed to traverse between two fixed anchor points
- Safe on-site installation, no channel cutting or hot work permit required
- Simple and easy to handle and transport
- Comes with two locking mechanisms
- Suitable for applications where no overhead fixing points are available
- Safety factor: 5:1

## The Installation

- Secure each end of the Span-Lock wire to a fixed anchor point using the zip-clips supplied
- Pass the wire through the zip-clip in the direction of the arrow
- Pass through or around your required suspension and back through the zip-clip leaving 15cm of wire protruding
- Use a tensioning tool to apply tension to the wire
- Always confirm engagement of the zip-clip on the wire by pushing the pin in the opposite direction to the arrows indicated

Zip-Clip is able to offer a comprehensive catenary calculation service. Please contact our technical team on **+44 1686 623366** for more information.

**When fixing from purlins, always consult with the purlin manufacturer to advise loading capabilities, in conjunction with using the Zip-Clip calculation service.**

CODE	DESCRIPTION	SWL	PACK QTY
GLHCS5Y	5 Mtr horizontal suspension system	30kg	10
GLHCS10Y	10 Mtr horizontal suspension system	30kg	10
GLHCS15Y	15 Mtr horizontal suspension system	30kg	10
GLHCS20Y	20 Mtr horizontal suspension system	30kg	10
GLHCS30Y	30 Mtr horizontal suspension system	30kg	10
GLHCS40Y	40 Mtr horizontal suspension system	30kg	10
GLHCS5P	5 Mtr horizontal suspension system	75kg	10
GLHCS10P	10 Mtr horizontal suspension system	75kg	10
GLHCS15P	15 Mtr horizontal suspension system	75kg	10
GLHCS20P	20 Mtr horizontal suspension system	75kg	10
GLHCS30P	30 Mtr horizontal suspension system	75kg	10
GLHCS40P	40 Mtr horizontal suspension system	75kg	10
GLHCS5N	5 Mtr horizontal suspension system	100kg	10
GLHCS10N	10 Mtr horizontal suspension system	100kg	10
GLHCS15N	15 Mtr horizontal suspension system	100kg	10
GLHCS20N	20 Mtr horizontal suspension system	100kg	10
GLHCS30N	30 Mtr horizontal suspension system	100kg	10
GLHCS40N	40 Mtr horizontal suspension system	100kg	10

**Ensure a distance of at least 1.6 x the height of the beam is left between the zip-clip and the structure. Do not exceed an angle of 60°**

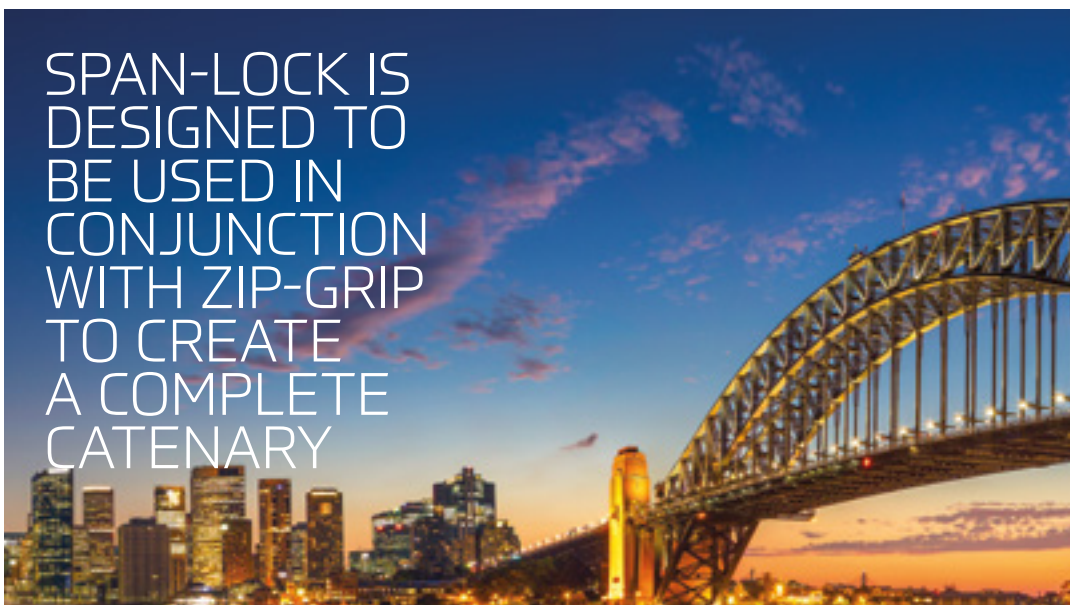

## ZIP-ROD



### SUITABLE FOR:

- Building suspensions in corrosive environments

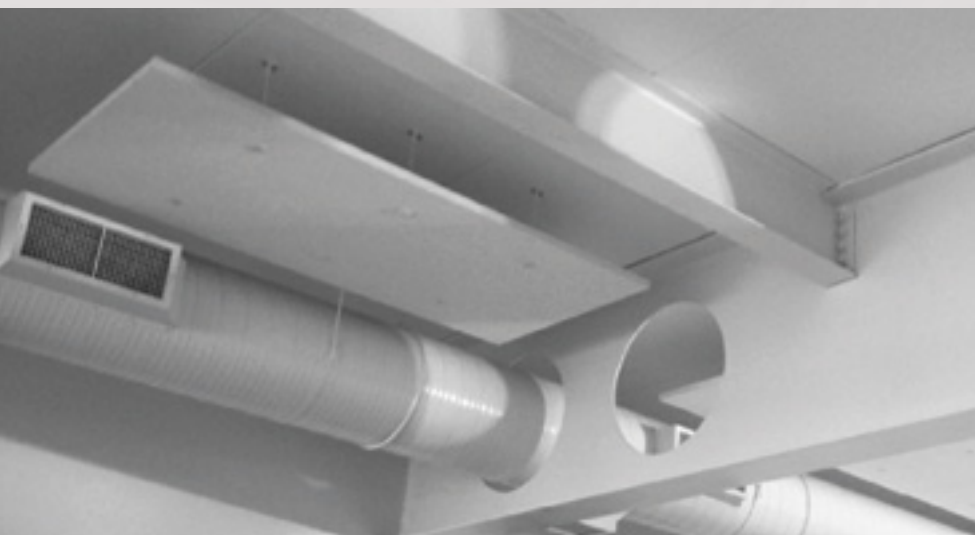

### The Specifics:

Zip-Rods offer a method of supporting services in corrosive environments. Thermoplastic threaded rods and accessories which can be utilised in the same way as galvanised threaded rod and bracketry.

### The Applications

Suitable for lightweight electrical installations into the following environments:

- Data centres
- Food processing
- Medical
- Chemical
- Swimming Pools
- Marine

### The Features and Benefits

- Thermo Plastic Polypropylene
- High molecular weight
- Chemically/Biologically inert
- Impervious to water
- Will not crack
- Will not rot
- Does not corrode
- Does not delaminate

### IMPORTANT INFORMATION

Please consult with Zip-Clip Technical Department before commencing installations to ensure product is suitable for use.

## ZIP-ROD

### The Installation

- Utilise in the same way as traditional rod systems
- Cut rods to desired lengths using a saw or tin snips
- Use nuts and washers or T-nuts to fix rods to ceilings or services

CODE	DESCRIPTION	SWL	PACK QTY
PP10M1	M10 polypropylene threaded support, 1000mm	30kg	1
PP10M2	M10 polypropylene threaded support, 2000mm	30kg	1
PP10	M10 hex nut polypropylene	30kg	10
PP10TC	M10 contour head t nut connector polypropylene	30kg	10
PP10TF	M10 flat head t nut connector polypropylene	30kg	10
PP10W	M10 washer polypropylene	30kg	10



## ACCESSORIES

CODE	DESCRIPTION	PACK QTY
CUT1	Heavy Duty Wire Cutters	1
CUT3	Heavy Duty Cutters for P Wire	1
TT1	Tensioning Tool	1
CPA1	Corner Protector	50
CPA1MAG	Magnetic Corner Protector	50
CH1	Chan-Lock Hanger	10
AC10	2 Way Screw Down Locking Device 8kg SWL 3:1 SF	10
UNI1	M6 x 20mm Universal Eyebolt with Flange Nut	10
UNI2	M6 x 45mm Universal Eyebolt with Flange Nut	10
UNI3	M8 x 25mm Universal Eyebolt with Flange Nut	10
UNI6M60	M6 x 50mm Closed Eyebolt	10
UNI8M60	M8 x 60mm Closed Eyebolt	10
UNI10M60	M10 x 75mm Closed Eyebolt	10
ATLDM6	M6 Standard Drop In Anchor	10
ATLDM8	M8 Standard Drop In Anchor	10
ATLDM10	M10 Standard Drop In Anchor	10
ATLDM6/ST	Standard Setting Tool for M6 Drop in Anchor	1
ATLDM8/ST	Standard Setting Tool for M8 Drop in Anchor	1
ATLDM10/ST	Standard Setting Tool for M10 Drop in Anchor	1
PVC100S	PVC 100M Reel x 3mm O	1
PVC100P	PVC 100M Reel x 6mm O	1
HCB1	90 degree bracket with 70mm and 5.0mm hole, 1.3mm gauge 10kg SWL	10
HCB2	90 degree bracket with 70mm and 5.0mm hole, 1.3mm gauge 50kg SWL	10
HCB3	90 Degree bracket with 6.5mm holes, 2.0mm gauge 90kg SWL	10
MA6810	Multiwedge Decking Fixing	10
MA300HEX	300mm Magnetic Bit Holder for MA6810	1
CLA1	Universal Concrete Anchor	50
CLA2	Concrete Spike	50
T920514	Vertical Flange Clip 1-5mm	10
T920515	Vertical Flange Clip 5-7mm	10
HCBP1	Shot Fired Fastener for Concrete and Steel	10
SFN19	19mm Ballistic Point Nail	100
SFN27	27mm Ballistic Point Nail	100
SFSCG	Powder Actuated Cartridge – Low Power	100
SFSCY	Powder Actuated Cartridge – Medium Power	100
SFSCR	Powder Actuated Cartridge – High Power	100

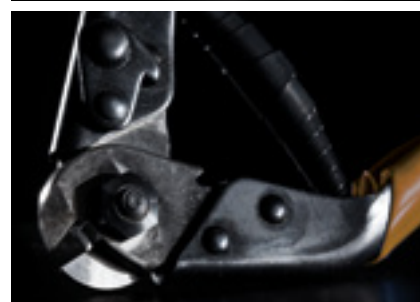
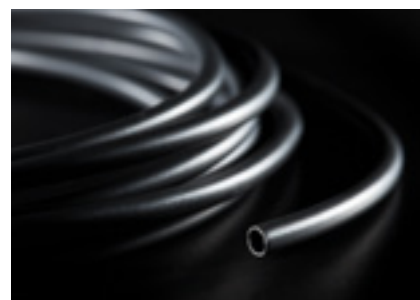
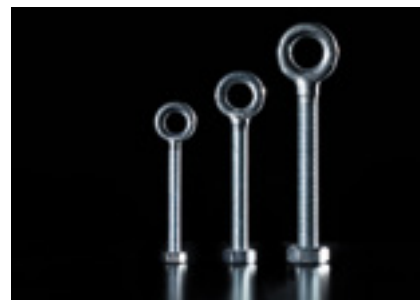

## Specialist Applications

Zip-Clip Ltd is renowned for its unique problem solving solutions. Over the past number of years we have designed and developed a range of systems tailored to overcome troublesome applications. With our highly trained technical managers and our extensive knowledge of the fixings market we can confidently design a solution for your requirements. Examples of our abilities are as below:

### Tunnel Solution

A solution was found for the Hatfield and Hindhead road tunnels for the suspension of a linear heat detection

cable. The solution was required as the linear cable did not travel in a straight line due to the ventilation and lighting equipment in its path. Zip-Clip were able to develop a bespoke low carbon stainless steel solution designed for this harsh environment that could be installed quickly with minimum disruption.

### Internally Cladded Buildings

With the increasing number of internally cladded buildings being specified, finding a suitable anchor point is not always possible. Zip-Clip designed a solution for the Pirelli Tyre Distribution Centre in Burton-on-Trent by utilising a unique self tapping anchor which did not affect the integrity of the cladding.

Zip-Clip is able to provide special products for many applications:

- Seismic areas
- Christmas decorations
- Acoustic supports
- Pest control
- Museum installations

Each drawing is tailored for specific needs. A unique number is attributed to each drawing, allowing ease of re-ordering and product continuity.



## SPECIFICATIONS

### Calculation Services

Zip-Clip are able to offer a free of charge drawing calculation service

**Step 1:** E-mail your drawing to [info@zip-clip.com](mailto:info@zip-clip.com)

**Step 2:** Our technical department will contact you with a few simple questions

**Step 3:** A full recommendation and quotation will follow. A unique project drawing number will be issued for reference.

The Zip-Clip Drawing Calculation Service is proving to be a big success with contractors.

### On-site Pull Tests

To add peace of mind to our already independently tested systems we offer an on-site pull test which will be validated and certified by CFA. With so many variants in concrete (ie flint, pebbles...), this unique free service is very reassuring.

### Architectural Supports

Zip-Clip also supplies a full range of aesthetically pleasing cable supports. The systems are safe and easy to use with fingertip adjustment for precise height adjustment with no tools required. The product is ideal for supporting lighting systems, cable management, store displays and signage.

### Specialist Support Brackets

Zip-Clip have developed a number of specialist brackets to enable the installer to suspend M & E services as quickly as possible. Zip-Clip designed these systems not only to speed up installations, but also to reduce the need for assembly on site. These support brackets can also be used in conjunction with modular designed systems.

A brief example of the large number of designed brackets include:

### Brace Bracket

This bracket can be used as a primary installation or as a retrofit solution. The brackets can be used in conjunction with a choice of anchors.





# SPECIFICATIONS

## WIRE ROPE

### Galvanised wire

WIRE CODE	SWL OF WIRE	CONSTRUCTION	TENSILE STRENGTH
G	15kg	7x7 (6/1) RHRL	1960N/mm <sup>2</sup>
S	50kg	7x7 (6/1) RHRL	1960N/mm <sup>2</sup>
Y	120kg	7x7 (6/1) RHRL	1960N/mm <sup>2</sup>
P	300kg	7x19 (6/1) RHRL	1960N/mm <sup>2</sup>
N	500kg	7x19 (6/1) RHRL	1960N/mm <sup>2</sup>

\*5:1 Safety Factor

### Angular Performance

The table below shows the effect on the Safe Working Load when working at an angle from the vertical

WIRE CODE	VERTICAL	15°	30°	45°	60°
G	15kg	14.40kg	12.90kg	10.50kg	7.50kg
S	50kg	48kg	43kg	35kg	25kg
Y	120kg	115.2kg	103.2kg	84kg	60kg
P	300kg	288kg	258kg	210kg	150kg
N	500kg	480kg	430kg	350kg	250kg
LOAD	100%	96%	86%	70%	50%

\*5:1 Safety Factor

### Stainless Steel Wire

WIRE CODE	SWL	CONSTRUCTION	GRADE
G	8kg	7X7 (6/1) RHR	AISI316
S	45kg	7X7 (6/1) RHRL	AISI316
Y	100kg	7X7 (6/1) RHRL	AISI316
P	200kg	7X19 (6/1) RHRL	AISI316
N	450kg	7X19 (6/1) RHRL	AISI316

\*5:1 Safety Factor

The high tensile wire we supply is galvanised and manufactured to the highest standards incorporating a 7 x 7 and 7 x 19 construction, meeting the BSEN 12385 standard.

BSMA 29/1983 standard also meeting the AISI 3136 requirements

The diagram below shows the construction of the 7x7 wire braids

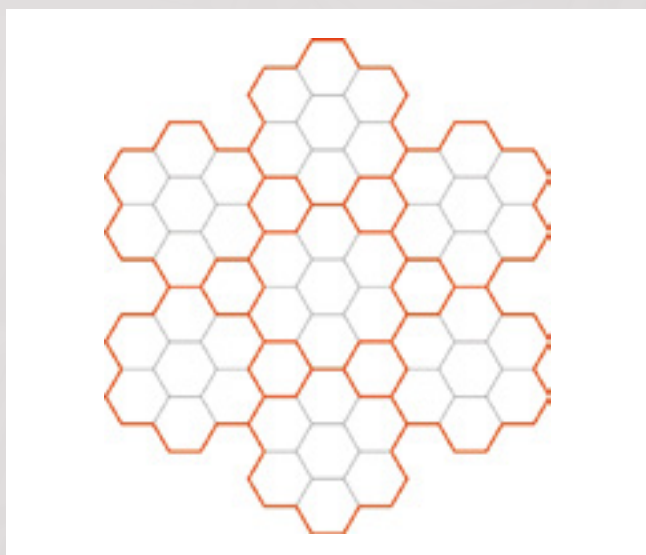

The diagram below shows the construction of the 7 x 19 wire braids

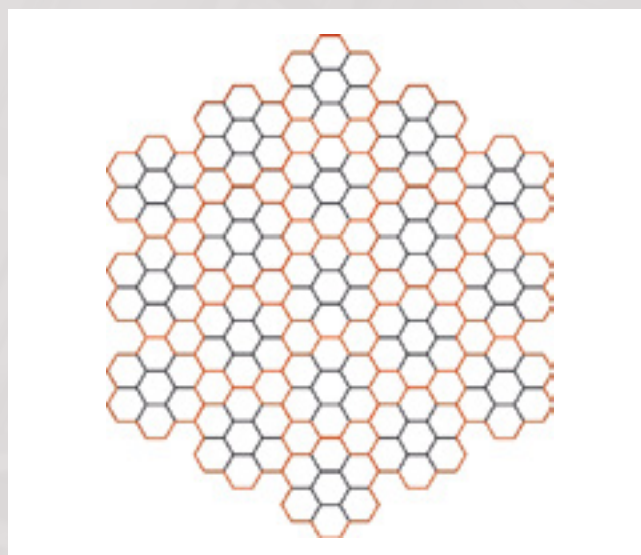

## SPECIFICATIONS

### ZIP-CLIPS

#### PHYSICAL PROPERTIES

Density	6,700kg/m <sup>3</sup> at 21°C
Solidification Shrinkage	1.17%
Casting Shrinkage	0.6% (pressure diecasts)
Freezing Range	-381 to -387°C
Melting Point	400 to 420°C
Specific Heat Capacity	418.1 J/kg/°C at 20 to 100°C
Thermal Expansion	27 10 (-6) linear per °C at 20 to 100°C
Thermal Conductivity	108.9 W/m/hr/m <sup>2</sup> /°C at 70 to 140°C
Electrical Conductivity	26% IACS
Electrical Resistivity	6.5359 um ohm cm at 20°C

#### MECHANICAL PROPERTIES

	As Cast	Aged
Tensile Strength (MPa)	328	269
Shear Strength (MPa)	262	-
Elongation (% in 51mm)	7	13
Hardness (Brinell – 500kg)	91	80
Impact Strength (Energy, Joules)	65.1	54.2
Fatigue Strength 5 x 10 cycles (MPa)	56.5	-

#### TYPICAL ANALYSIS – ALLOYING ELEMENTS

Aluminium	4%
Copper	1%
Magnesium	0.05%

#### TYPICAL ANALYSIS – IMPURITIES

Iron	< 0.01%
Lead	< 0.003%
Cadmium	0.003%
Tin	< 0.001%
Nickel	< 0.001%
Silicon	< 0.01%



# ENVIRONMENTAL POLICY

Zip-Clip Ltd recognizes that its activities impact on the environment at local, regional and global levels and acknowledges a responsibility for the protection of the environment and of the health and safety of its employees and the wider community.

## ZIP-CLIP LTD IS COMMITTED TO:

- Promoting the protection of the environment and minimizing the impact of all its activities upon each of the local, regional and global environments both directly and through its influence on others
- Contributing to a sustainable and healthy future by conserving natural resources and by minimizing avoidable waste and pollution
- Reducing the use of fossil fuels through improvements to energy efficiency and the substitution of renewable energy resources
- Developing effective waste management and recycling procedures and using recycled and recyclable materials where possible
- Increasing awareness of environmental responsibilities amongst staff

## TO ACHIEVE THESE GOALS WE WILL:

- Educate and train staff in environmental matters as appropriate
- Progressively reduce the amount of waste generated
- Market products, which create a minimum environmental damage, and use its purchasing to influence to:
  - Promote production of such products
  - Ensure that all public communications are true and unambiguous
  - Respect the interests of neighbours and the world community
  - Review our policies as an ongoing matter





STRENGTH | SUSPENSION | STYLE

## A FUSION OF **ENGINEERING** AND **DESIGN**

*YOU'RE IN GOOD COMPANY...  
ALFA ROMEO, AMAZON, ASDA,  
B SKY B, B&Q, DALLAS COWBOYS  
STADIUM, FERRARI, HARRY  
POTTER STUDIOS, HITACHI,  
IKEA, JAGUAR/LAND ROVER,  
JOHN LEWIS, KPMG, LONDON  
2012 OLYMPICS, MALL OF THE  
EMIRATES, MARKS & SPENCER,  
MORRISONS, NATURAL HISTORY  
MUSEUM, PRETTY GREEN, ROLLS-  
ROYCE, ROYAL LONDON HOSPITAL,  
SELFRIDGES, SKI DUBAI, TESCO,  
TOPMAN & WAITROSE.*

### **ZIP-CLIP LTD**

Offas Dyke Business Park,  
Welshpool, Powys, SY21 8SS,  
United Kingdom

Tel: +44 (0) 1686 623 366  
Fax: +44 (0) 1686 623 377

[www.zip-clip.com](http://www.zip-clip.com)

### **ZIP-CLIP S.A.R.L**

3 Rue de Téhéran  
75008 Paris, France

Tel: 08 11 46 55 70  
Fax: 08 11 46 55 71  
Email: [france@zip-clip.com](mailto:france@zip-clip.com)

[www.zip-clip.fr](http://www.zip-clip.fr)

### **ZIP-CLIP PTY LTD**

4/324 Settlement Road,  
Thomastown, VIC 3074,  
Australia

Email: [sales@zip-clip.com.au](mailto:sales@zip-clip.com.au)  
Tel: 0431 464 272

[www.zip-clip.com.au](http://www.zip-clip.com.au)